



MOTORIZATION PRICING GUIDE

TABLE OF CONTENTS

| | |
|--|-------|
| Introduction | 2 |
| Power Types..... | 3-4 |
| Battery Powered | 3 |
| Solar Powered | 3 |
| Plug-In Powered | 4 |
| In-Wall / Hard Wired Powered..... | 4 |
| Pricing | 5 |
| Motor Compatibility..... | 6 |
| Somfy® | 6 |
| Tilt | 6 |
| Rollease Automate..... | 6 |
| Motor Tube Compatibility..... | 7 |
| Compatible Tube Sizes..... | 7 |
| Maximum Tube Width..... | 7 |
| Somfy® Motor Specifications | 8 |
| Somfy® Motors | 9-11 |
| Roller, Roman & Woven Wood Motors..... | 9-10 |
| Honeycomb Motors..... | 11 |
| Horizontal Sheer & Blind Motors | 11 |
| Somfy® Controls & Accessories | 12-13 |
| RTS Remotes..... | 12 |
| AC Cord Options | 12 |
| DC Options | 12 |
| Additional Options | 13 |
| Power panels | 13 |
| Rollease Motors | 14-15 |
| Motor Specifications..... | 14 |
| Roller, Roman & Woven Wood Motors..... | 14 |
| Honeycomb Motors..... | 14 |
| Horizontal Sheer & Blinds Motors..... | 15 |
| Lift & Tilt Specifications | 15 |
| Rollease Controls & Accessories | 16 |
| Controls | 16 |
| Accessories | 16 |
| Child Safety & Warranty | 17 |

INTRODUCTION

INTRODUCTION

The automation of window treatments is the fastest growing segment of the window covering industry. From simple battery operated motors and complete systems that are fully compatible with most automation systems, to motors that are integrated into the window treatment and totally concealed, home or building automation options offer endless decoration possibilities.

Choosing the right automation option for your window treatment is the first step towards creating a beautiful and functional motorized window covering. There are numerous motorization choices to be made and deciding on what's best for your application can vary based upon window size, how your shade operates (vertically or horizontally), and/or shade weight.

Automated Motorized Shades has simplified the process of selecting and ordering motors and controls for all of the products that Automated Motorized Shades manufactures. Products have been placed in an easy to use, categorized format covering all the bases from battery operated motors to hard wired applications. Just follow the easy step by step process in this guide to find the solution that best suits your customer's needs. This price guide is designed to provide helpful automation information so that motorization can and should become an essential part of what you offer to your customers. From concept to completion, Automated Motorized Shades is ready to assist you with all of your automation needs.



POWER TYPES

BATTERY POWERED

- No wires to conceal and no need for an electrician
- Built in receiver for all battery operated products
- Perfect for situations where access to electrical wiring is not possible
- Ideal for projects with smaller window openings
- Simple battery replacement using standard lithium batteries
- Battery clips are provided for mounting the battery wands in various configurations
- All battery motors can be converted to a plug-in motor with a transformer

Size limitations may apply (See product specifications for details)



SOLAR POWERED

- The WireFree™ Solar Pack includes an easy-to-install, low profile solar panel, battery pack and wiring harness
- Replaces traditional battery solutions as an autonomous system for 12 Volt WireFree™ motors
- The WireFree™ Solar Pack efficiently captures sunlight through interior windows to effectively replenish the energy consumed by the motor and has been designed to work through seasonal variations
- NiMH battery acts as a “reservoir” of stored energy, which means less disposal of single use batteries & reduced energy consumption
- Solar Panel Measures 11 7/8" L x 1 5/8" W x 1/2" H
- 5 year warranty on Solar Panels



POWER TYPES

PLUG-IN POWERED

- Simply plugs into standard outlet
- Available for AC (high voltage) or DC motors (low voltage)
- AC motors have a greater capacity than battery motors and can be coupled to operate multiple shades simultaneously
- Maintenance Free (no batteries to change)
- Wires will be exposed and may need to be concealed with a top and/or side treatment (Valance or Side Panels)
- Electrician may be required if existing outlets are not convenient to the shade location
- Products that include built in receivers are:
 - Roller Shade Collection
 - Woven Wood Collection
 - Roman Shade Collection
 - Honeycomb Collection
 - Sheer Collection
 - Glydea Drapery Rod
 - Horizontal Blinds
 - Tilt only for 2" & 2 ½"
 - Lift & Tilt for 1", 2" & 2 ½"
- Products that require an external receiver are:
 - BTX 5060 Drapery Rod



IN-WALL / HARD WIRED POWERED

- Available in either DC (low voltage) or AC (high voltage) versions depending on the application needs
- AC motors may require an electrician to run and connect all wires
- DC motors may not require an electrician to run and connect all the wires.
- Maintenance free
- DC power panels can be configured to power multiple motors from a centralized location



PRICING

PRICING MOTORIZATION

This motorization price guide is designed to make pricing automated window treatments a simple and easy process. Just follow this step by step guide (as outlined below) to calculate a fast, accurate price for all of your motorized needs.

STEPS FOR PRICING

1. Determine what type of motorization/power choice best suits your customer's needs
2. Find the price for your motorization following the easy steps outlined on the product pages
3. Add any surcharges at the bottom of the page and total all prices
4. Apply any discounts
5. Using our order form, Email your orders to orders@amsshades.com or fax 954.974.0529

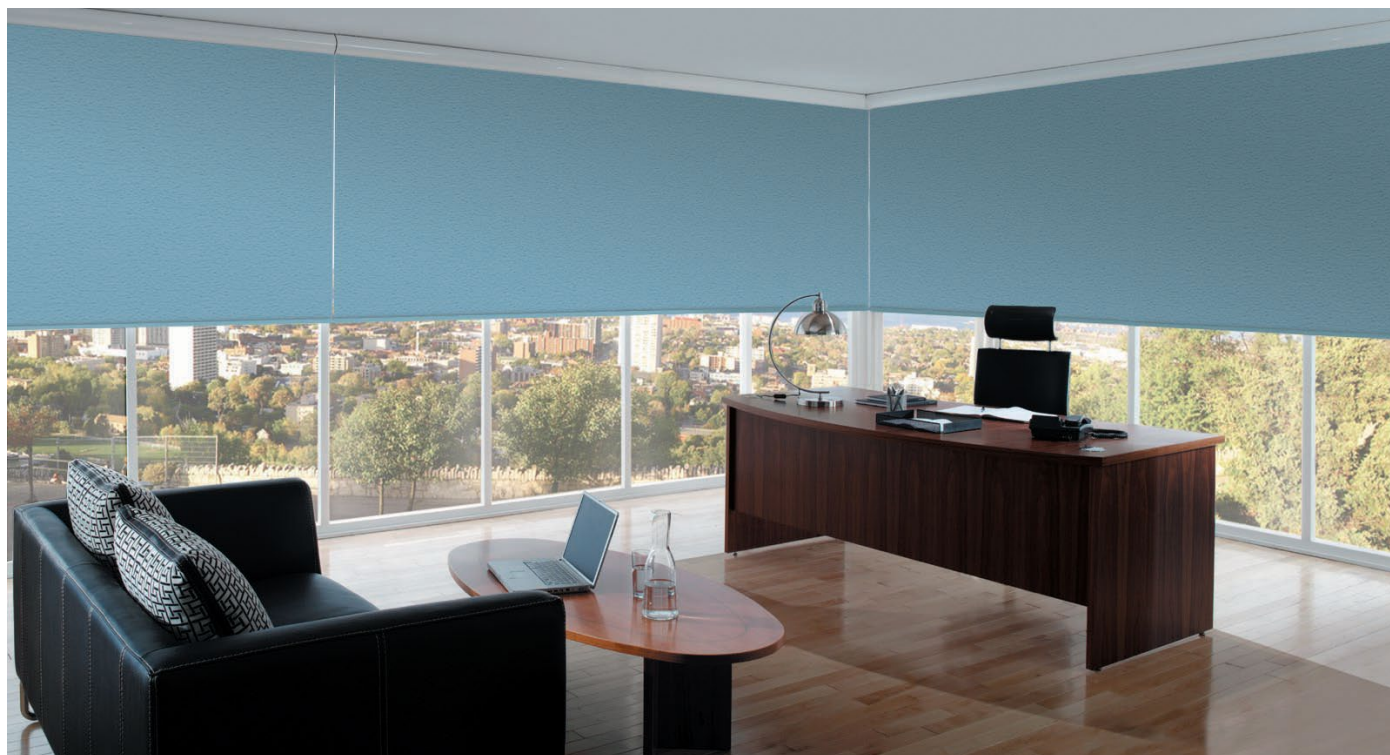

MOTOR COMPATIBILITY

SOMFY®

| Motor | AC | DC | RTS | RS485 | DCT | 4 Wire | 2 Wire | Roller Shades | Roman Shades | Parallel Shades | Honey-comb | Horizontal Sheer | Woven Woods |
|----------------------|------|--------|-----|-------|-----|--------|--------|---------------|--------------|-----------------|------------|------------------|-------------|
| Somfy R 28 | | 12V | ✓ | | | | ✓ | ✓ | ✓ | | | ✓ | ✓ |
| Sonesse 30 Wirefree | | Li-Ion | ✓ | | | | | ✓ | ✓ | ✓ | ✓ | ✓ | ✓ |
| Sonesse ST 30 | | 24V | ✓ | ✓ | ✓ | | | ✓ | ✓ | ✓ | ✓ | ✓ | ✓ |
| Sonesse Ultra Qt 504 | | 24V | ✓ | ✓ | | | | ✓ | ✓ | | | | ✓ |
| Sonesse ST 404 | 120V | | ✓ | | | ✓ | | ✓ | ✓ | ✓ | ✓ | ✓ | ✓ |
| Sonesse ST 406 | 120V | | ✓ | | | ✓ | | ✓ | ✓ | | | | ✓ |
| Sonesse ST 506 | 120V | | ✓ | ✓ | ✓ | ✓ | | ✓ | ✓ | | | | ✓ |
| Sonesse ST 510 | 120V | | ✓ | ✓ | | ✓ | | ✓ | ✓ | | | | ✓ |
| Sonesse Ultra Qt 506 | 120V | | ✓ | ✓ | | ✓ | | ✓ | ✓ | | | | ✓ |
| CL-32 | | 12V | | | | | | | | | ✓ | | |

TILT

| Motor | AC | DC | RTS | RS485 | DCT | 4 Wire | 2 Wire | |
|--------------------------|------|-----|-----|-------|-----|--------|--------|-------------------|
| Tilt Wire Free | | 12V | ✓ | | | | | Horizontal Blinds |
| ST 30 (Lift & Tilt) | | 24v | ✓ | | ✓ | | | Horizontal Blinds |
| ST 406 CTS (Lift & Tilt) | 120v | | ✓ | ✓ | | ✓ | | Horizontal Blinds |

ROLLEASE AUTOMATE

| Motor | AC | DC | RF | RS485 | DCT | 4 Wire | 2 Wire | Roller Shades | Roman Shades | Parallel Shades | Honey-comb | Horizontal Sheer | Woven Woods |
|-------------|------|--------|----|-------|-----|--------|--------|---------------|--------------|-----------------|------------|------------------|-------------|
| Li-ion 1.1 | | LI-Ion | ✓ | | | | | ✓ | ✓ | ✓ | | ✓ | ✓ |
| Li-ion Q2.0 | | LI-Ion | ✓ | | | | | ✓ | ✓ | ✓ | | ✓ | ✓ |
| Li-ion 3.0 | | LI-Ion | ✓ | | | | | ✓ | ✓ | | | | ✓ |
| Li-ion Q3.0 | | LI-Ion | ✓ | | | | | ✓ | ✓ | | | | ✓ |
| ACRF Q6 | 120V | | ✓ | | | | | ✓ | ✓ | | | | ✓ |
| ACRF Q10 | 120V | | ✓ | | | | | ✓ | ✓ | | | | ✓ |

MOTOR TUBE COMPATIBILITY

SOMFY®

| TUBE DIAMETER | 1 ¼" | 1 ½" | 40mm | 2" | 2 ½" | 3" | 3 ½" | 4 ¼" |
|----------------------|------|------|------|----|------|----|------|------|
| Somfy R-28 | ✓ | ✓ | | | | | | |
| Sonesse 30 Wirefree | | ✓ | | ✓ | | | | |
| Sonesse ST 30 | | ✓ | | ✓ | | | | |
| Sonesse Ultra Qt 504 | | | | ✓ | ✓ | ✓ | | |
| Sonesse ST 404 | | | ✓ | ✓ | | | | |
| Sonesse ST 406 | | | ✓ | ✓ | | | | |
| Sonesse ST 506 | | | | ✓ | ✓ | ✓ | ✓ | ✓ |
| Sonesse ST 510 | | | | ✓ | ✓ | ✓ | ✓ | ✓ |
| Sonesse Ultra Qt 506 | | | | ✓ | ✓ | ✓ | ✓ | ✓ |

ROLLEASE AUTOMATE

| TUBE DIAMETER | 1 ¼" | 1 ½" | 40mm | 2" | 2 ½" | 3" | 3 ½" | 4 ¼" |
|---------------|------|------|------|----|------|----|------|------|
| Li-ion 1.1 | ✓ | ✓ | | | | | | |
| Li-ion Q2.0 | | ✓ | | ✓ | | | | |
| Li-ion 3.0 | | | | ✓ | ✓ | | | |
| Li-ion Q3.0 | | | | ✓ | ✓ | | | |
| ACRF Q6 | | | | ✓ | ✓ | | | |
| ACRF Q10 | | | | ✓ | ✓ | | | |

MAXIMUM TUBE WIDTH

| TUBE DIAMETER | 1 ¼" | 1 ½" | 40mm | 2" | 2 ½" | 3" | 3 ½" | 4 ¼" |
|-----------------|------|------|------|------|------|------|------|------|
| Width in Inches | 72" | 96" | 120" | 132" | 168" | 192" | 192" | 210" |

SOMFY® MOTOR SPECIFICATIONS

RTS

| Motor | Power | Min Width | Max Width | Min Length | Max Length | Coupled Max | Max Weight | Quiet |
|----------------------|---------|-----------|-----------|------------|------------|-------------|------------|-------|
| Somfy R-28 | DC | 16" | 96" | 14" | 120" | NA | | No |
| Sonesse 30 Wirefree | Battery | 28" | 132" | 12" | 144" | +1 | 17lbs | Yes |
| Sonesse ST 30 | DC | 19" | 96" | 12" | 144" | NA | | Yes |
| Sonesse Ultra Qt 504 | DC | 39" | 156" | 12" | 192" | +1 | 35 lbs | Yes |
| Sonesse ST 404 | AC | 24" | 120" | 12" | 144" | +1 | 35 lbs | Yes |
| Sonesse ST 406 | AC | 25" | 120" | 12" | 192" | +1 | 52 lbs | Yes |
| Sonesse ST 506 | AC | 34" | 210" | 12" | 192" | +2 | 52 lbs | Yes |
| Sonesse ST 510 | AC | 35" | 210" | 12" | 220" | +2 | 88 lbs | Yes |
| Sonesse Ultra Qt 506 | AC | 40" | 210" | 12" | 156" | +2 | 52 lbs | Yes |
| CL-32 | DC | 20" | 120" | 12" | 96" | NA | | No |

4 WIRE

| Motor | Power | Min Width | Max Width | Min Length | Max Length | Coupled Max | Max Weight | Quiet |
|----------------------|-------|-----------|-----------|------------|------------|-------------|------------|-------|
| Sonesse ST 404 | AC | 22" | 120" | 12" | 144" | +1 | 35 lbs | Yes |
| Sonesse ST 406 | AC | 23" | 120" | 12" | 192" | +1 | 52 lbs | Yes |
| Sonesse ST 506 | AC | 32" | 168" | 12" | 192" | +1 | 52 lbs | Yes |
| Sonesse ST 510 | AC | 32" | 220" | 12" | 220" | +2 | 88 lbs | Yes |
| Sonesse Ultra Qt 506 | DC | 40" | 168" | 12" | 192" | +2 | 52 lbs | Yes |

RS485

| Motor | Power | Min Width | Max Width | Min Length | Max Length | Coupled Max | Max Weight | Quiet |
|----------------------|-------|-----------|-----------|------------|------------|-------------|------------|-------|
| Sonesse Ultra Qt 504 | DC | 42" | 156" | 12" | 192" | +1 | 35 lbs | Yes |
| Sonesse ST 506 | AC | 34" | 168" | 12" | 192" | +2 | 52 lbs | Yes |
| Sonesse ST 510 | AC | 35" | 220" | 12" | 220" | +2 | 88 lbs | Yes |
| Sonesse Ultra Qt 506 | AC | 39" | 168" | 12" | 192" | +2 | 52 lbs | Yes |

DCT

| Motor | Power | Min Width | Max Width | Min Length | Max Length | Coupled Max | Max Weight | Quiet |
|-----------------|-------|-----------|-----------|------------|------------|-------------|------------|-------|
| Sonesse 30 DCT | DC | 30" | 168" | 12" | 192" | NA | | Yes |
| Sonesse 506 DCT | AC | 30" | 168" | 12" | 192" | +2 | 52 lbs | Yes |
| Sonesse 510 DCT | AC | 30" | 220" | 12" | 220" | +2 | 88 lbs | Yes |

SOMFY® MOTORS

ROLLER, ROMAN & WOVEN WOOD MOTORS

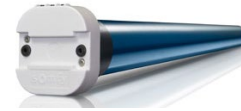

DC MOTORS

| MOTOR | POWER | POWER SOURCE | CONTROL TYPE | RETAIL |
|------------------------------|------------|--------------|--------------|---------|
| Somfy R28-RTS* | DC Battery | 12v | RTS | \$700 |
| Sonesse 30 Wirefree‡ | Li-Ion | 12v | RTS | \$600 |
| Sonesse ST30-RTS† | DC 24v | 24v | RTS | \$1,070 |
| Sonesse Ultra Qt 504 DC-RTS† | DC 24v | 24v | RTS | \$1,475 |
| Somfy R-28 (2 Wire)† | DC | 24v | Switch | \$615 |

*Price Includes Battery Pack with Batteries
 ‡Requires 1 Recharger per Order
 †Price Includes DC Transformer
 R-28 and ST-30 Series Widths Should Not Exceed 96"



SONESSE 400 SERIES

| MOTOR | POWER | POWER SOURCE | CONTROL TYPE | RETAIL |
|----------------------------|-------|--------------|--------------|---------|
| Sonesse ST 404-RTS | AC | 120v | RTS | \$1,025 |
| Sonesse ST 406-RTS | AC | 120v | RTS | \$1,075 |
| Sonesse ST 404-WT (4-Wire) | AC | 120v | Switch | \$1,000 |
| Sonesse ST 406-WT (4-Wire) | AC | 120v | Switch | \$1,100 |

Widths Should Not Exceed 120"

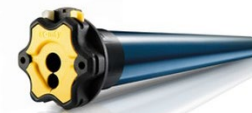

SONESSE 500 SERIES

| MOTOR | POWER | POWER SOURCE | CONTROL TYPE | RETAIL |
|---------------------------|-------|--------------|--------------|---------|
| Sonesse ST 506-RTS | AC | 120v | RTS | \$1,110 |
| Sonesse ST 510-RTS | AC | 120v | RTS | \$1,335 |
| Sonesse Ultra Qt 506-RTS | AC | 120v | RTS | \$1,200 |
| Sonesse Ultra Qt 506A2-WT | AC | 120v | Switch | \$1,125 |
| Sonesse ST 506-WT | AC | 120v | Switch | \$1,000 |
| Sonesse ST 510-WT | AC | 120v | Switch | \$1,125 |

Recommended for Shade Widths: Up to 168" for Sonesse 506 & 510 motors

Prices subject to change without notice

SOMFY® MOTORS

ROLLER, ROMAN & WOVEN WOOD MOTORS (CONT.)

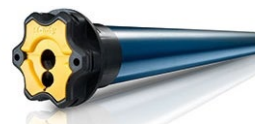

SOMFY DRY CONTACT MOTORS

| MOTOR | POWER | POWER SOURCE | CONTROL TYPE | RETAIL |
|-------------------|-------|--------------|--------------|---------|
| Somfy 30 DCT* | DC | 24v | Switch | \$1,135 |
| Sonesse 506-S2DCT | AC | 120v | Switch | \$1,200 |
| Sonesse 510-S2DCT | AC | 120v | Switch | \$1,300 |

*Price Includes Transformer



SOMFY RS485 MOTORS

| MOTOR | POWER | POWER SOURCE | CONTROL TYPE | RETAIL |
|--------------------------------|-------|--------------|--------------|---------|
| Sonesse ST30-RS485 | DC | 24v | RS485 | \$1,335 |
| Sonesse Ultra Qt DC 504-RS485* | DC | 24v | RS485 | \$1,600 |
| Sonesse ST 506-RS485 | AC | 120v | RS485 | \$1,275 |
| Sonesse ST 510-RS485 | AC | 120v | RS485 | \$1,375 |
| Sonesse Ultra Qt DC 506-RS485* | AC | 120v | RS485 | \$1,325 |

*Price Includes Transformer

HONEYCOMB MOTORS

RTS



| MOTOR | POWER | POWER SOURCE | CONTROL TYPE | RETAIL |
|------------|------------|--------------|--------------|--------|
| CL 32-RTS* | DC Battery | 12v | RTS | \$750 |

*Price Includes Battery Pack with Batteries and AMS Deluxe Headrail

| MOTOR | POWER | POWER SOURCE | CONTROL TYPE | RETAIL |
|------------|-------|--------------|--------------|-----------|
| ST 30-RTS* | DC | 24v | RTS | See Chart |

*Price Includes RL-2024 Headrail

| 48" | 72" | 96" | 120" |
|--------|--------|--------|--------|
| \$1255 | \$1300 | \$1360 | \$1400 |

Prices subject to change without notice

SOMFY® MOTORS

HONEYCOMB MOTORS (CONT.)

| MOTOR | POWER | POWER SOURCE | CONTROL TYPE | RETAIL |
|-------------|-------|--------------|--------------|-----------|
| ST 404-RTS* | AC | 120v | RTS | See Chart |

**Price Includes RL-4120 Headrail*

| 48" | 72" | 96" | 120" | 144" | 192" |
|--------|--------|--------|--------|--------|--------|
| \$1340 | \$1380 | \$1440 | \$1480 | \$1540 | \$1640 |

HORIZONTAL SHEER & BLIND MOTORS



RTS

| MOTOR | POWER | POWER SOURCE | CONTROL TYPE | RETAIL |
|-----------|------------|--------------|--------------|--------|
| R-28-RTS* | DC Battery | 12v | RTS | \$830 |

**Price Includes Battery Pack with Batteries and AMS Deluxe Headrail*

| MOTOR | POWER | POWER SOURCE | CONTROL TYPE | RETAIL |
|----------------------|--------|--------------|--------------|---------|
| ST 30-RTS | DC | 24v | RTS | \$1,200 |
| Sonnesse 30 Wirefree | Li-Ion | 12v | RTS | \$730 |

| MOTOR | POWER | POWER SOURCE | CONTROL TYPE | RETAIL |
|------------|-------|--------------|--------------|---------|
| ST 404-RTS | AC | 120v | RTS | \$1,089 |

LIFT & TILT SPECIFICATIONS

| Type | Power | Min Width | Max Width | Min Length | Max Length | Max Weight | Quiet |
|--------------------------|-------|-----------|-----------|------------|------------|------------|-------|
| Tilt Wire Free | DC | 24" | 144" | NA | 120" | 35 lbs | No |
| ST-406 CTS (Lift & Tilt) | AC | 28 | 108 | NA | 96" | 36 lbs | Yes |

Prices subject to change without notice

SOMFY® CONTROLS & ACCESSORIES



Telis Pure
4 Channel



Decoflex Table
Top Accessory

RTS REMOTES

| REMOTE | PURE (WHITE) | BLACK | SILVER | IVORY |
|---|--------------|-------------|-------------|-------|
| Telis - 1 Channel RTS Remote | \$134 | \$209 | \$209 | NA |
| Telis - 4 Channel RTS Remote | \$185 | \$269 | \$269 | NA |
| Telis - 16 Channel RTS Remote | \$561 | NA | \$561 | NA |
| Decoflex Wirefree RTS Keypads* | \$335 | \$365 | NA | \$365 |
| Decoflex Table Top Accessory | \$79 | \$79 | \$79 | NA |
| Modulis - 1 Channel RTS Remote | \$265 | NA | NA | NA |
| Modulis - 4 Channel RTS Remote | \$390 | NA | NA | NA |
| Telis Patio - 1 Channel RTS Remote† | \$185 | NA | NA | NA |
| Telis Patio - 4 Channel RTS Remote† | \$249 | NA | NA | NA |
| Telis 1 Chronis with Timer | \$325 | NA | \$350 | NA |

*Available in 1-5 Channel Models

†Available in White with Blue Trim

| REMOTE | PURE (WHITE) | BLACK | SILVER | DESIGNER |
|------------------------------------|----------------|-------------|-------------|----------|
| SIMU Remote (1 channel) | \$149 | \$149 | \$149 | \$149 |
| SIMU Remote (5 channel) | \$185 | \$185 | \$185 | \$185 |
| SIMU Wall Switch (1 channel) | \$134 | \$134 | \$134 | \$134 |
| SIMU Wall Switch (5 channel) | \$174 | \$174 | \$174 | \$174 |
| Smooove RTS Wall Switch | \$185 | NA | NA | NA |
| Optional Smooove Wall Plates | Included | \$19 | \$19 | \$19 |

AC CORD OPTIONS

| | |
|----------------------------------|---------------|
| 12' Cord - 500 Series Only | \$42 |
| 18' Cord - 500 Series Only | \$65 |
| 24' Cord - 500 Series Only | \$80 |
| 400 Series Cord Over 11' | +\$6 per foot |

DC OPTIONS

| | |
|----------------------------------|-------|
| 12v Transformer | \$275 |
| 24v Transformer | \$200 |
| Battery Wand | \$145 |
| Dual Battery with Harness | \$300 |
| Solar Panel Kit (12v Only) | \$300 |
| SPDT | \$59 |
| DPDT | \$96 |
| Wirefree Charger | \$64 |

Prices subject to change without notice

SOMFY® CONTROLS & ACCESSORIES



Thermo Sunis Indoor
Wirefree RTS



MyLink

ADDITIONAL OPTIONS

| | |
|---|---------|
| Mylink | \$475 |
| Sunis Indoor Wirefree RTS | \$485 |
| Thermo Sunis Indoor Wirefree RTS..... | \$622 |
| RTS Repeater | \$468 |
| URTSI-II | \$935 |
| ZRTSI..... | \$880 |
| ZBDMI (Zigbee to Digital Motor Interface) | \$625 |
| ZDMI (Z-Wave to Digital Motor Interface) | \$625 |
| Data Hub | \$225 |
| Data Hub Plus | \$600 |
| POE - Power Over Ethernet | \$350 |
| 6 Button SDN Switch | \$350 |
| 8 Button SDN Switch | \$380 |
| RS485 Limit Setting Tool..... | \$650 |
| Somfy Connect LTI..... | \$1,350 |
| Somfy Connect Universal Automation Interface (UAI) Plus | \$2,655 |
| Wago PPlugs..... | \$80 |
| WEP Plate..... | \$120 |
| Motorized Shade Coupler | \$215 |

POWER PANELS

| | |
|---|------------------|
| SDN Power Panels | \$4,000 |
| SDN Data Panels..... | \$4,200 |
| Power Panels (5, 10, 15, 20 Motors) | Call for Pricing |

Prices subject to change without notice

ROLLEASE MOTORS

RF MOTOR SPECIFICATIONS

| Motor | Power | Min Width | Max Width | Min Length | Max Length | Coupled Max | Max Weight | Quiet |
|-------------|---------|-----------|-----------|------------|------------|-------------|------------|-------|
| Li-ion 1.1 | Battery | 22" | 96" | 12" | 96" | NA | 9 lbs | No |
| Li-ion Q2.0 | Battery | 30" | 96" | 12" | 144" | NA | 17 lbs | Yes |
| Li-ion 3.0 | Battery | 31" | 144" | 12" | 160" | +1 | 27 lbs | No |
| Li-ion Q3.0 | Battery | 38" | 168" | 12" | 160" | +1 | 27 lbs | Yes |
| ACRF Q6 | AC | 28" | 168" | 12" | 192" | +2 | 52 lbs | Yes |
| ACRF Q10 | AC | 36" | 168" | 12" | 220" | +2 | 88 lbs | Yes |

ROLLER, ROMAN & WOVEN WOOD MOTORS



DC/BATTERY MOTORS

| MOTOR | POWER | POWER SOURCE | CONTROL TYPE | RETAIL |
|--|-----------------------|--------------|--------------|--------|
| Li-Ion 1.1 (25 mm) | Internal Battery..... | Li-Ion | RF | \$450 |
| Li-Ion Q2.0 (28 mm)..... | Internal Battery..... | Li-Ion | RF | \$534 |
| Li-Ion Q3.0 (45 mm)..... | Internal Battery..... | Li-Ion | RF | \$708 |
| Li-Ion Q3.0 (45 mm) with Silent Pin End..... | Internal Battery..... | Li-Ion | RF | \$758 |

Note: One Charger included with each Rollease motorized shade order
 Note: One remote included with each Rollease motorized shade order per each 5 shades
 (One Shade: RF White Single Channel Remote)
 (Up to 5 Shades: RF White Single Channel Remote or RF White 15 Channel Remote)

AC MOTORS



| MOTOR | POWER | POWER SOURCE | CONTROL TYPE | RETAIL |
|----------------|----------|--------------|--------------|--------|
| ACRF Q6 | AC | 120v | RF | \$735 |
| ACRF Q10 | AC | 120v | RF | \$575 |

HONEYCOMB MOTORS

DC/BATTERY MOTORS



| MOTOR | POWER | POWER SOURCE | CONTROL TYPE | RETAIL |
|---|----------|---------------|--------------|-----------|
| 28mm Battery DCRF (Internal Battery)* | DC | Battery | RF | See Chart |

*Price Includes RL-2024 Headrail

Note: To mount a motor on any shade NOT manufactured by Automated Motorized Shades you must add \$199 to the cost of the motor

| 48" | 72" | 96" | 120" |
|--------|--------|--------|--------|
| \$1067 | \$1155 | \$1156 | \$1190 |

ROLLEASE MOTORS

HORIZONTAL SHEER & BLINDS MOTORS



DC/BATTERY MOTORS

| <i>MOTOR</i> | <i>POWER</i> | <i>POWER SOURCE</i> | <i>CONTROL TYPE</i> | <i>RETAIL</i> |
|------------------------------|------------------|---------------------|---------------------|---------------|
| 25mm Battery DCRF | DC Battery | 12v | RF | \$450 |
| 28mm Battery Quiet DCRF..... | DC Battery | 12v | RF | \$534 |

Note: To mount a motor on any shade NOT manufactured by Automated Motorized Shades you must add \$199 to the cost of the motor

ROLLEASE CONTROLS & ACCESSORIES



RF White 15
Channel Remote



RF White Wall
Switch

CONTROLS

| | | |
|--|----------------------|-------|
| RF White 1 Channel Decorator Wall Switch (Cut In) | MTRF-WS-1C..... | \$104 |
| RF White 15 Channel LED Decorator Switch (Cut In) | MTRF-WS-15CLED | \$128 |
| RF White 5 Channel Decorator Surface Mount Switch | MTRF-WS5-FLUSH | \$120 |
| RF White 1 Channel Remote | MTRF-REM-1C..... | \$131 |
| RF White 15 Channel LED Remote with Leveling Control Sun Sensor..... | MTRF-REM-5CLED | \$158 |

ACCESSORIES

| | | |
|--|----------------------|-------|
| Recharger for DC Battery Motors (18/25/28/35/45 mm)..... | MTDCB-CHARGE | \$64 |
| Solar Panel for 18/25/28/35/45 mm Battery Motors | MTSOPLAN-B | \$300 |
| Battery Tube for 18/25 mm DCRF (no Battery) Mtrs..... | MTBWAND18-15 | \$56 |
| DC Battery Motor Cable extender 6" / 155 mm | MTDCB-CBLXT6 | \$16 |
| DC Battery Motor Cable extender 48" / 1220 mm | MTDCB-CBLXT48 | \$21 |
| DC Battery Motor Cable extender 96" / 2440 mm | MTDCB-CBLXT96 | \$27 |
| Automate Pulse | WIFIBRIDGE-KIT | \$467 |
| Motorized Shade Coupler (45 mm Motor Only) | | \$215 |

CHILD SAFETY & WARRANTY

CHILD SAFETY

Every product we send out meets or exceeds the latest safety standards as set forth by the Consumer Product Safety Council and the Window Covering Manufacturers Association. For enhanced safety, Automated Motorized Shades offers cordless and motorized window treatments.

REMEMBER THESE SAFETY RULES...

- For children's bedrooms only install window coverings that are cordless.
- Any window coverings in your home that were made before 2001, should be replaced with today's newer, safer models.
- Do not place furniture near windows that have window coverings with cords.
- Keep all cords out of reach from small children. Do this by securing tasseled pull cords out of reach with a cord cleat, and anchoring continuous-loop cords to the wall with safety devices.
- Always be sure to lock and firmly secure cords in position.
- Products such as Roman or Woven Wood Shades that have accessible back cords, should not be installed within reach of children.

All products come with safety labels attached. This is to help raise awareness of the potential safety risks associated with the products you purchase. If you have any concerns, please do not hesitate to contact us directly. You may also directly contact any of the associations that create the safety standards with any questions or concerns. Child safety is our top priority!

WARRANTY

Automated Motorized Shades guarantees all products manufactured in our facility to be free from defects due to faulty workmanship and/or materials. We are so confident about our quality and dependability that we back our manual shades with a limited lifetime warranty, our motors with a 5 year limited warranty, and our custom printed shades with a 3 year warranty against fading. All warranties are effective from the original invoice date of the product.

This guarantee does not apply to damage to exterior shades caused by high winds and/or extreme weather conditions. Any roller shade or parts which fail due to abuse, accident, theft, alterations, improper use or

installation, or gradual color fading, are also excluded from this warranty.

Automated Motorized Shades reserves the right to inspect products and will replace or repair any product found to be defective as a result of faulty workmanship or materials.

Shipping charges, trip charges and labor costs for measuring and installation and/or removal of old or current products are excluded. This

warranty is available to the original owner/purchaser and is non-transferable. Automated Motorized Shades' warranty is designed to ensure a thoroughly satisfying experience with your window treatment product. Certain restrictions may apply.

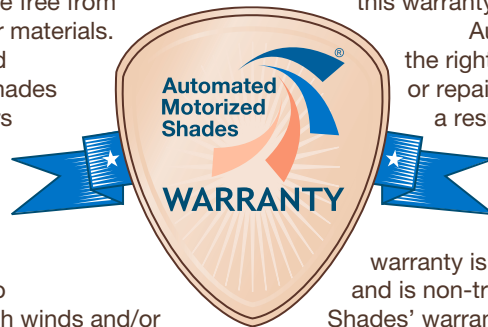



ROLLER SHADE COLLECTION
PRICING GUIDE

TABLE OF CONTENTS

| | |
|------------------------------|-------|
| Basic Guidelines..... | 1 |
| Overview..... | 2 |
| Measuring Instructions..... | 3-4 |
| Fabric Selection..... | 5-7 |
| Price Charts..... | 8-11 |
| Price Charts 1..... | 8 |
| Price Charts 2..... | 8 |
| Price Charts 3..... | 9 |
| Price Charts 4..... | 9 |
| Price Charts 5..... | 10 |
| Price Charts 6..... | 10 |
| Price Charts 7..... | 11 |
| Price Charts 8..... | 11 |
| Options..... | 12-17 |
| Child Safety & Warranty..... | 18 |

BASIC GUIDELINES

- Shades can be ordered inside mount (deductions from ordered size will be taken), outside mount (no deductions on width will be taken), and fabric width (outside bracket to outside bracket size will vary depending on control being used).
- Measure the desired width and height. For outside mount it is recommended to add at least 2” to width to minimize light gap.
- Shades that are not mounted level may telescope (shade rolling off the tube to one side or the other) and may cause shade damage.
- Shades width that is less than half the height may cause shades to telescope even if shades are mounted level. The larger the length to width ratio, the more likely and severe the telescoping may become. Telescoping damage is not covered under warranty.
- Shades may be ordered with clutches, cordless, and motorized (see motorization pricing guide).

OVERVIEW

PROUDLY MANUFACTURED IN THE USA

With an extensive selection of fabrics, manual controls and automation options, the Automated Motorized Shades Roller Shade collection is a complete solution for all of your solar control needs. From fabrics that offer complete light blockage to materials that provide excellent protection from the sun's harmful rays while still permitting an unobstructed view, you are sure to find a choice that will serve your customers' needs. Here are a few of the many features available in this line:

| Available Features & Options | Benefit |
|---|--|
| Continuous Loop Clutch Operation | Smooth, easy lifting with exact positioning |
| Universal, Color Coordinated Mounting Brackets with Covers | Easy installation and removal of the shade Provides a finished look even without valances |
| Heat Sealed Bottom Hem | Sleek, clean and durable - available with sealed ends |
| Optional Fabric Wrapped Hem Bar Color Coordinated | Decorative hem bar covered by fabric on the front, color coordinated exposed on the back |
| Optional Cassette Valance | Valance system with fabric insert, installs as a complete system |
| Optional Fascia & Fabric Valance | Available in matching colors, provides a clean method of concealing shades |
| Motorization Available | Eliminates lift cords, raises and lowers shades at the touch of a button |
| Color Coordinating Nylon Beaded Chain or Stainless Steel Chain | Standard on every manual shade |

Fabrics widths vary. Check the color coordination chart to determine the maximum width for your selected fabric.

FABRIC ORIENTATION

- When displaying multiple shades in the same room, we recommend all shades be ordered with the same fabric orientation for a consistent look.
- Due to the nature of solar/roller shades, the material may curl along its vertical edge when the fabric is railroaded. This is not considered a defect of the product.
- Shades ordered within the maximum width of the fabric will be vertically oriented.
- Shades ordered wider than the maximum width of the fabric will be horizontally oriented (the width is used for the height) commonly referred to as railroaded. See the fabric compatibility index to determine if the fabric you select can be railroaded.
- Railroaded shades with an ordered height greater than the maximum fabric width minus 6 inches may have a visible seam. See the fabric compatibility index to determine if the fabric you select can be seamed and if the seam will be visible.

**Visible Seams Will Be Placed as High Up as Possible*

**STANDARD
FABRIC
ORIENTATION**

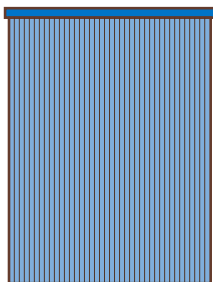

Fig. 1

**FABRIC TURNED
WIDTH FOR HEIGHT**

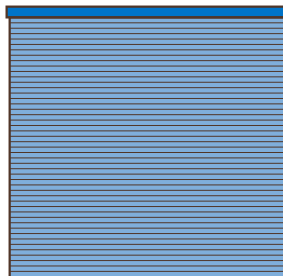

Fig. 2

**LARGE SHADE MAY
HAVE VISIBLE SEAMS**

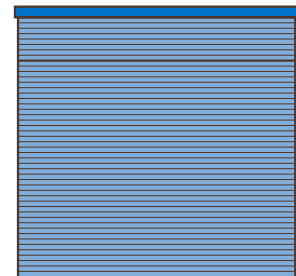

Fig. 3

MEASURING INSTRUCTIONS

MEASUREMENTS

Accurate measurements are absolutely essential. The measurements you provide are used first to price the shade, and then to custom fabricate it to the specified size. The dimensions supplied on the order form must be correct for the shade to properly fit the window opening. As a dealer, it is your responsibility to measure and order accurately. Automated Motorized Shades cannot be held accountable for incorrect ordering information.

BASIC GUIDELINES

Measuring for Roller Shades is similar to measuring for most window coverings. Follow these basic guidelines to ensure a smooth installation:

- Always use a steel tape measure, preferably $\frac{3}{4}$ " to 1" wide.
- **Measure width first, then height.**
- Measure each window separately, even if they appear to be the same size.
- Survey the window area carefully and make additional measurements, if necessary.
- Record your measurements on a worksheet.

CONSISTENCY

- To ensure color consistency and avoid dye lot variation, please order all shades for the same room at the same time.
- Due to the nature of the weaving process, some imperfections in the weave are normal.
- Pattern Alignment: Due to random design, exact alignment of some shade weaves is not possible, nor is centering of the pattern across the width of shades and fabric covered valance options.

The diagram shown below is for clutch & battery operated roller shades.

WHEN SHADE IS ORDERED IB

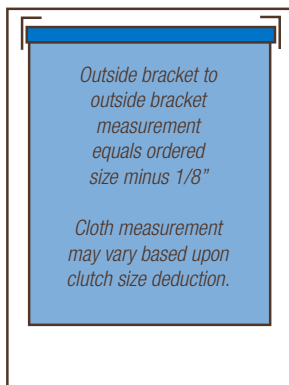

Fig. 4

INSIDE MOUNT (IB)

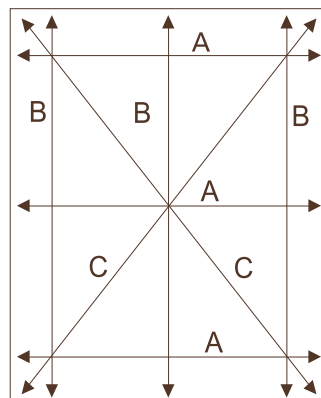

Fig. 5

INSIDE OR OUTSIDE MOUNT

How you take your measurements will vary depending upon whether the shade fits within the window opening (inside mount or IB Fig.4 and Fig. 5) or overlaps the window opening (outside mount or OB Fig. 6 and Fig.7) With inside mounts, note that the shade fabric will be about $\frac{13}{8}$ " narrower than the window opening, so if complete privacy and light control is desired, optional side panels and bottom channels can be ordered.

"ROUNDING" YOUR MEASUREMENTS

Dimensions on the order form should be accurate to within $\frac{1}{8}$ ". However, with inside mounts, always round the width measurement down to the nearest $\frac{1}{8}$ ". Rounding up could result in a shade that is too wide to fit within the window opening. For example, for an inside mount, $\frac{3}{16}$ " would round to $\frac{1}{8}$ ". The only time this is not the case is when measuring for Parallel Shades, which need to be accurate to a $\frac{1}{16}$ "

MEASURING FOR INSIDE MOUNTS (FIG. 5)

1. Measure the width about $1\frac{1}{4}$ " down from the top of the window, which typically is where the installation brackets will be mounted. Remember to round down to the nearest $\frac{1}{8}$ ". This measurement is the ordering width of the shade. Do not make any deductions from this width - all necessary deductions will be made automatically when the shade is fabricated. Measure the width at the center and bottom of the window. If the width narrows by more than 1" from the top measurement, the customer should consider an outside mount.
2. Measure the height of the window opening at three locations, as shown in Fig. 5 and order the shortest measurement. Again, make no deductions. All necessary deductions will be made when the shade is fabricated.
3. Measure window on the diagonal. If the two diagonal dimensions are not exactly the same, it may be more appropriate to specify an outside mount shade for optimal light control and privacy.
4. Measure depth of window for mounting brackets

Note: Acceptable tolerances for all dimensions are plus or minus $\frac{3}{32}$ "

MEASURING INSTRUCTIONS

MEASURING FOR OUTSIDE AND CEILING MOUNTS

- Measure the desired width and height. To minimize light leakage, it is recommended that the shade overlap the window opening at least 1 ½” on each side, as well as at the top and bottom.
- Measure the width at the location where you want the brackets, and use this measurement as your ordering width for the shade.
- Measure the height from where the top of the roller will be located to where you want the bottom of the shade.
- Please note the allowances pictured below for Roller Shades (Fig.6) to assure proper overlap or order Roller Shade as a cloth measurement (Fig.7).

CLOTH MEASUREMENTS FOR ROLLER SHADES

- Measure the desired width and height. To minimize light leakage, it is recommended that the shade overlap the window opening at least 1 ½” on each side, as well as at the top and bottom. As with inside mounts, do not make any deductions from your measurements.
- Measure the width at the location where you want the fabric, and use this measurement as your ordering width for the shade.
- Measure the height from where the top of the roller shade brackets will be located to where you want the bottom of the shade.
- Please note the allowances pictured (Fig. 7) to assure that you have sufficient room to mount the bracket.

TELESCOPING (ALSO KNOWN AS TRACKING)

Telescoping is defined as the shade rolling off the tube to one side or the other while being raised. The main causes are:

- A shade that is installed out of level. The more out of level a shade is installed, the more pronounced the telescoping.
- Shades that are mounted uneven on the roller tube or cut out of square. (Automated Motorized Shades uses state of the art shade cutting tables and mounting methods that virtually eliminate this cause)
- Width vs. Height – When the width of a roller shades equals less than fifty percent of the height, telescoping can occur even if the shade is installed level. This issue becomes exaggerated as the shade becomes narrower and/or taller. This is especially important to note on Motorized Roller Shades, since the motor can not sense that the shade may be telescoping, it will continue to run causing irreparable damage to the shade cloth. Telescoping damage is not covered under warranty and is considered to be an improper installation issue. A viable option for narrow/tall windows is the Solar Roman Shade.

WHEN SHADE IS ORDERED OB

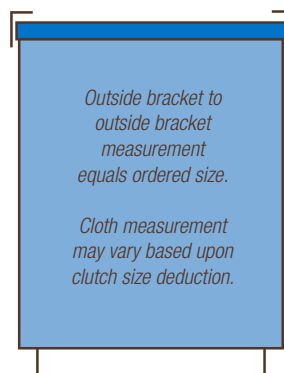

Fig. 6

WHEN SHADE IS ORDERED TO CLOTH SIZE

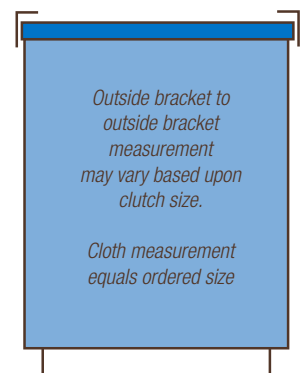

Fig. 7

FABRIC SELECTION

| Vendor | Name | Roller Shade Price Chart | Opacity | Maximum Fabric Width | Railroad Available |
|--------|--------------------|--------------------------|-------------|----------------------|--------------------|
| Phifer | Sheerweave© 1000 | 2 | 25% | 96" | Yes |
| Phifer | Sheerweave© 2000 | 5 | 5% | 126" | Yes |
| Phifer | Sheerweave© 2100 | 4 | 10% | 98" | Yes |
| Phifer | Sheerweave© 2360 | 4 | 10% | 98" | Yes |
| Phifer | Sheerweave© 2390 | 5 | 5% | 126" | Yes |
| Phifer | Performance + 2390 | 8 | 5% | 96" | Yes |
| Phifer | Sheerweave© 2410 | 5 | 3% | 126" | Yes |
| Phifer | Performance + 2410 | 8 | 3% | 96" | Yes |
| Phifer | Sheerweave© 2500 | 6 | 1% | 126" | Yes |
| Phifer | Performance + 2500 | 8 | 1% | 96" | Yes |
| Phifer | Sheerweave© 2701 | 6 | 1% | 126" | Yes |
| Phifer | Sheerweave© 2703 | 5 | 3% | 126" | Yes |
| Phifer | Sheerweave© 2705 | 5 | 5% | 126" | Yes |
| Phifer | Sheerweave© 2710 | 4 | 10% | 98" | Yes |
| Phifer | Sheerweave© 3000 | 3 | 14% | 96" | Yes |
| Phifer | Sheerweave© 4000 | 5 | 5% | 126" | Yes |
| Phifer | Sheerweave© 4100 | 4 | 10% | 98" | Yes |
| Phifer | Sheerweave© 4400 | 6 | 3% | 126" | Yes |
| Phifer | Sheerweave© 4500 | 5 | 5% | 98" | Yes |
| Phifer | Sheerweave© 4550 | 5 | 5% | 98" | Yes |
| Phifer | Sheerweave© 4600 | 6 | 3% | 98" | Yes |
| Phifer | Sheerweave© 4650 | 6 | 3% | 98" | Yes |
| Phifer | Sheerweave© 4800 | 6 | 1% | 126" | Yes |
| Phifer | Sheerweave© 4901 | 6 | 1% | 98" | Yes |
| Phifer | Sheerweave© 4903 | 6 | 3% | 98" | Yes |
| Phifer | Sheerweave© 5000 | 6 | 3-10% | 98" | No |
| Phifer | Sheerweave© 7000 | 8 | Blackout | 118" | Yes |
| Phifer | Sheerweave© 7100 | 6 | Blackout | 96" | Yes |
| Phifer | Sheerweave© 7200R | 5 | Blackout | 118" | No |
| Phifer | Sheerweave© 7250R | 4 | Translucent | 118" | No |
| Phifer | Sheerweave© 7400 | 8 | Blackout | 118" | No |
| Phifer | Sheerweave© 7450 | 7 | Translucent | 118" | No |
| Phifer | Sheerweave© 7500 | 5 | Blackout | 118" | Yes |
| Phifer | Sheerweave© 7500R | 3 | Blackout | 118" | Yes |
| Phifer | Sheerweave© 7600 | 7 | Blackout | 118" | No |
| Phifer | Sheerweave© 7650 | 5 | Translucent | 118" | No |
| Phifer | Sheerweave© 7700R | 6 | Blackout | 118" | No |
| Phifer | Sheerweave© 7750R | 4 | Translucent | 118" | No |

Cut Yardage Available in Limited Patterns - Call Customer Service For Pricing and Availability.

FABRIC SELECTION

| Vendor | Name | Roller Shade Price Chart | Opacity | Maximum Fabric Width | Railroad Available |
|--------|------------------------|--------------------------|-------------|----------------------|--------------------|
| Phifer | Sheerweave© 7800 | 7 | Blackout | 118" | No |
| Phifer | Sheerweave© 7850 | 5 | Translucent | 118" | No |
| Phifer | Basic 3% & 5% | 4 | 3% | 98" | Yes |
| Phifer | Infinity2 1% | 8 | 1% | 98" | Yes |
| Phifer | Infinity2 3% | 8 | 3% | 98" | Yes |
| Phifer | Infinity2 5% | 7 | 5% | 98" | Yes |
| Phifer | Suntex 80 | 3 | 25% | 96" | Yes |
| Phifer | Suntex 90 | 3 | 10% | 96" | Yes |
| Phifer | Suntex 95 | 5 | 5% | 126" | Yes |
| Phifer | Suntex 90 Design | 6 | 10% | 96" | Yes |
| Phifer | Suntex 97 | 6 | 3% | 126" | Yes |
| Mermet | Avila Daylight | 3 | Translucent | | |
| Mermet | Avila Twilight | 4 | Blackout | 110" | Yes |
| Mermet | Avila Twilight FR | 7 | Blackout | 110" | Yes |
| Mermet | E Screen 1% | 6 | 1% | 122" | Yes |
| Mermet | E Screen 3% | 5 | 3% | 122" | Yes |
| Mermet | E Screen 5% | 4 | 5% | 122" | Yes |
| Mermet | E Screen 10% | 4 | 10% | 122" | Yes |
| Mermet | E Screen Chroma 3% | 8 | 3% | 94" | Yes |
| Mermet | E Screen Deco 1% | 6 | 1% | 122" | Yes |
| Mermet | E Screen Deco 3% | 6 | 3% | 122" | Yes |
| Mermet | E Screen Kool Black 1% | 8 | 1% | 122" | Yes |
| Mermet | E Screen Kool Black 3% | 8 | 3% | 122" | Yes |
| Mermet | E Screen Kool Black 5% | 7 | 5% | 122" | Yes |
| Mermet | Flocke | 8 | Blackout | 94" | Yes |
| Mermet | M Deco Screen 3% | 5 | 3% | 98" | No |
| Mermet | M Deco Screen 5% | 5 | 5% | 98" | No |
| Mermet | M Screen 1% | 6 | 1% | 122" | Yes |
| Mermet | M Screen 3% | 5 | 3% | 122" | Yes |
| Mermet | M Screen 5% | 4 | 5% | 122" | Yes |
| Mermet | M Screen Chroma 3% | 8 | 3% | 112" | Yes |
| Mermet | Natte 3% | 6 | 3% | 98" | Yes |
| Mermet | Natte 5% | 6 | 5% | 98" | Yes |
| Mermet | Natte 10% | 6 | 10% | 98" | Yes |
| Mermet | S Screen 1% | 6 | 1% | 122" | No |
| Mermet | S Screen 4% | 5 | 4% | 122" | No |
| Mermet | S Screen Naturals 5% | 5 | 5% | 98" | No |
| Mermet | T Screen 1% | 6 | 3% | 98" | Yes |
| Mermet | T Screen 3% | 5 | 3% | 98" | Yes |

Cut Yardage Available in Limited Patterns - Call Customer Service For Pricing and Availability.

FABRIC SELECTION

| Vendor | Name | Roller Shade Price Chart | Opacity | Maximum Fabric Width | Railroad Available |
|--------|---------------------------|--------------------------|-----------------|----------------------|--------------------|
| Mermet | T Screen Deco 1% | 6 | 1% | 122" | Yes |
| Mermet | T Screen Deco 3% | 5 | 3% | 122" | Yes |
| Mermet | T Screen Deco 5% | 5 | 5% | 122" | Yes |
| Mermet | T Screen Kool Black 1% | 7 | 1% | 122" | Yes |
| Mermet | T Screen Kool Black 3% | 7 | 3% | 122" | Yes |
| Mermet | T Screen Kool Black 5% | 7 | 5% | 122" | Yes |
| Mermet | Verona Daylight | 4 | 1% | 118" | Yes |
| Mermet | Verona Twilight | 7 | Blackout | 118" | Yes |
| Mermet | Vizela | 8 | Translucent | 94" | Yes |
| AMS | Blues | 6 | Translucent | 110" | Yes |
| AMS | Eco Lux | 7 | Translucent | 110" | Yes |
| AMS | Eco Silk | 6 | Translucent | 110" | Yes |
| AMS | Fashion Screen | 6 | 3% | 110" | Yes |
| AMS | Linen | 7 | Translucent | 110" | Yes |
| AMS | Linen Look B/O | 5 | Blackout | 94" | Yes |
| AMS | Mambo | 5 | Translucent | 110" | Yes |
| AMS | Milan B/O White Back | 6 | Blackout | 110" | Yes |
| AMS | Orient B/O Color Back | 4 | Blackout | 94" | Yes |
| AMS | Orient B/O FR | 5 | Blackout | 94" | Yes |
| AMS | Orient B/O White Back | 4 | Blackout | 94" | Yes |
| AMS | Orient Light Filtering | 3 | Translucent | 94" | Yes |
| AMS | Orient Light Filtering FR | 4 | Translucent | 94" | Yes |
| AMS | Orient Transparent | 3 | Transparent | 94" | Yes |
| AMS | Pompei | 7 | Transparent | 110" | Yes |
| AMS | Puglia | 4 | Transparent | 110" | Yes |
| AMS | Reve | 6 | Transparent | 110" | Yes |
| AMS | Rimini | 4 | Transparent | 110" | Yes |
| AMS | Satino | 7 | Translucent | 110" | Yes |
| AMS | Sorrento Blackout | 4 | Blackout | 110" | Yes |
| AMS | Swing | 7 | Translucent | 110" | Yes |
| AMS | Trento | 3 | Translucent | 110" | Yes |
| AMS | Trento B/O | 4 | Blackout | 110" | Yes |
| AMS | Varese | 7 | Transparent | 110" | Yes |
| AMS | Venezia | 4 | Transparent | 110" | Yes |
| AMS | Verona | 3 | Translucent | 94" | Yes |
| AMS | Verona B/O | 6 | Blackout | 100" | Yes |
| AMS | Vinyl FR | 4 | Blackout | 98.4" | Yes |
| AMS | Signature Series | 3 | 1%, 3%, 5%, 10% | 118" | Yes |
| VT | Vinyl Tech Blackout | 1 | Blackout | 72" | Yes |
| AMS | C Screen 3%, 5%, Linen | 5 | 5% | 118" | Yes |
| AMS | D Screen | 5 | 5% | 118" | Yes |

Cut Yardage Available in Limited Patterns - Call Customer Service For Pricing and Availability.

PRICE CHARTS 1 & 2

PRICE CHART 1

VINYL TECH BLACKOUT

← Width →

| | 37" | 46" | 55" | 64" | 73" | 78" | 84" | 96" | 109" | 121" | 132" | 144" | 156" | 168" |
|------|-----|-----|-----|-----|-----|-----|-----|-----|------|------|------|------|------|------|
| 36" | 103 | 133 | 162 | 184 | 202 | 269 | 278 | 308 | 399 | 426 | 503 | 528 | 551 | 585 |
| 48" | 111 | 139 | 174 | 204 | 218 | 280 | 303 | 351 | 435 | 458 | 543 | 578 | 585 | 628 |
| 60" | 118 | 147 | 181 | 214 | 232 | 301 | 322 | 377 | 474 | 543 | 567 | 601 | 628 | 667 |
| 72" | 127 | 164 | 195 | 227 | 248 | 346 | 389 | 444 | 528 | 667 | 715 | 782 | 847 | 927 |
| 84" | 137 | 171 | 210 | 243 | 262 | 373 | 410 | 484 | 601 | 710 | 817 | 834 | 916 | 979 |
| 96" | 142 | 180 | 216 | 258 | 295 | 395 | 444 | 519 | 667 | 801 | 852 | 886 | 979 | 1028 |
| 108" | 153 | 197 | 239 | 300 | 366 | 449 | 495 | 585 | 744 | 834 | 901 | 961 | 1017 | 1085 |
| 120" | 161 | 216 | 279 | 342 | 400 | 522 | 528 | 636 | 793 | 876 | 961 | 1010 | 1085 | 1150 |
| 132" | 177 | 237 | 303 | 369 | 430 | 556 | 563 | 681 | 843 | 928 | 1016 | 1065 | 1143 | 1212 |
| 144" | 193 | 255 | 327 | 394 | 462 | 588 | 601 | 725 | 891 | 981 | 1068 | 1122 | 1205 | 1273 |
| 156" | 206 | 276 | 349 | 422 | 493 | 623 | 637 | 768 | 942 | 1031 | 1123 | 1177 | 1265 | 1338 |
| 168" | 222 | 296 | 372 | 448 | 522 | 654 | 674 | 814 | 991 | 1084 | 1177 | 1234 | 1323 | 1398 |
| 180" | 238 | 317 | 394 | 475 | 552 | 686 | 711 | 858 | 1041 | 1137 | 1233 | 1289 | 1383 | 1460 |
| 192" | 253 | 337 | 417 | 502 | 584 | 721 | 749 | 903 | 1091 | 1188 | 1287 | 1345 | 1442 | 1523 |

Longer sizes are available with some limitations, contact customer service for pricing and information

PRICE CHART 2

PHIFER SHEERWEAVE® 1000

← Width →

| | 37" | 46" | 55" | 64" | 73" | 78" | 84" | 96" | 109" | 121" | 132" | 144" | 156" | 168" |
|------|-----|-----|-----|-----|-----|-----|-----|-----|------|------|------|------|------|------|
| 36" | 115 | 142 | 157 | 180 | 193 | 223 | 255 | 323 | 395 | 515 | 623 | 745 | 891 | 1024 |
| 48" | 129 | 150 | 171 | 201 | 222 | 242 | 283 | 349 | 444 | 550 | 674 | 809 | 980 | 1152 |
| 60" | 140 | 160 | 188 | 219 | 239 | 262 | 294 | 369 | 462 | 586 | 732 | 891 | 1078 | 1263 |
| 72" | 148 | 171 | 207 | 242 | 262 | 289 | 339 | 395 | 486 | 632 | 810 | 1018 | 1188 | 1366 |
| 84" | 175 | 196 | 226 | 260 | 290 | 328 | 362 | 434 | 533 | 685 | 867 | 1188 | 1366 | 1559 |
| 96" | 196 | 215 | 248 | 283 | 322 | 362 | 400 | 483 | 567 | 742 | 943 | 1338 | 1483 | 1663 |
| 108" | 255 | 274 | 314 | 353 | 393 | 442 | 476 | 558 | 624 | 805 | 1064 | 1483 | 1636 | 1780 |
| 120" | 277 | 301 | 335 | 376 | 431 | 491 | 530 | 617 | 705 | 891 | 1219 | 1631 | 1817 | 1944 |
| 132" | 303 | 331 | 367 | 412 | 471 | 538 | 583 | 677 | 777 | 971 | 1328 | 1772 | 1975 | 2124 |
| 144" | 328 | 358 | 397 | 447 | 510 | 585 | 637 | 739 | 849 | 1053 | 1436 | 1913 | 2132 | 2299 |
| 156" | 354 | 387 | 427 | 482 | 548 | 633 | 691 | 800 | 921 | 1133 | 1542 | 2052 | 2288 | 2477 |
| 168" | 378 | 414 | 457 | 516 | 587 | 678 | 744 | 859 | 991 | 1213 | 1650 | 2192 | 2446 | 2655 |
| 180" | 405 | 443 | 490 | 551 | 626 | 725 | 799 | 921 | 1063 | 1294 | 1758 | 2332 | 2603 | 2832 |
| 192" | 430 | 471 | 522 | 586 | 666 | 774 | 852 | 980 | 1133 | 1376 | 1866 | 2472 | 2761 | 3009 |

Longer sizes are available with some limitations, contact customer service for pricing and information

For more Options please see pages 14-20

Prices subject to change without notice

PRICE CHARTS 3 & 4

PRICE CHART 3

**PHIFER SHEERWEAVE[®] 3000, 7500R,
SUNTEX 80, SUNTEX 90, MERMET[®] AVILA DAYLIGHT
AUTOMATED MOTORIZED SHADES SIGNATURE SERIES 1%, 3%, 5% & 10%,
ORIENT LIGHT FILTERING & TRANSPARENT, TRENTO, VERONA**

← Width →

| | 37" | 46" | 55" | 64" | 73" | 78" | 84" | 96" | 109" | 121" | 132" | 144" | 156" | 168" |
|------|-----|-----|-----|-----|-----|-----|-----|------|------|------|------|------|------|------|
| 36" | 117 | 143 | 159 | 186 | 196 | 228 | 255 | 295 | 403 | 522 | 632 | 742 | 869 | 1008 |
| 48" | 129 | 151 | 175 | 202 | 224 | 245 | 287 | 317 | 447 | 560 | 678 | 819 | 966 | 1124 |
| 60" | 141 | 162 | 195 | 224 | 245 | 263 | 303 | 343 | 469 | 594 | 737 | 895 | 1077 | 1260 |
| 72" | 151 | 175 | 213 | 248 | 263 | 292 | 346 | 369 | 495 | 636 | 817 | 1048 | 1260 | 1403 |
| 84" | 177 | 197 | 228 | 267 | 295 | 331 | 369 | 403 | 539 | 692 | 874 | 1106 | 1350 | 1530 |
| 96" | 197 | 218 | 251 | 287 | 327 | 367 | 407 | 442 | 578 | 751 | 952 | 1315 | 1441 | 1595 |
| 108" | 245 | 267 | 317 | 351 | 373 | 444 | 492 | 571 | 648 | 799 | 1041 | 1441 | 1657 | 1845 |
| 120" | 277 | 301 | 351 | 382 | 444 | 505 | 556 | 632 | 711 | 862 | 1172 | 1581 | 1815 | 2030 |
| 132" | 305 | 333 | 388 | 423 | 493 | 560 | 619 | 701 | 789 | 952 | 1276 | 1721 | 1976 | 2204 |
| 144" | 333 | 367 | 425 | 463 | 539 | 616 | 682 | 769 | 869 | 1042 | 1383 | 1860 | 2135 | 2380 |
| 156" | 362 | 397 | 462 | 504 | 588 | 672 | 747 | 840 | 947 | 1133 | 1489 | 1998 | 2294 | 2556 |
| 168" | 389 | 428 | 499 | 544 | 636 | 728 | 809 | 910 | 1024 | 1223 | 1593 | 2139 | 2453 | 2733 |
| 180" | 417 | 461 | 534 | 585 | 684 | 782 | 872 | 981 | 1104 | 1312 | 1698 | 2278 | 2613 | 2910 |
| 192" | 445 | 493 | 572 | 626 | 733 | 839 | 935 | 1048 | 1182 | 1401 | 1804 | 2416 | 2774 | 3085 |

↑ Height ↓

Longer sizes are available with some limitations, contact customer service for pricing and information

PRICE CHART 4

**PHIFER SHEERWEAVE[®] 2100, 2360, 2710, 4100, 7250R, 7750R,
BASIC 3% & 5%, AVILA TWILIGHT (NON FR), VERONA DAYLIGHT
MERMET[®] E SCREEN 5% & 10%, M SCREEN 5%,
AUTOMATED MOTORIZED SHADES ORIENT B/O, ORIENT LIGHT
FILTERING FR, PUGLIA, RIMINI SORRENTO B/O,
TRENTO B/O WHITE BACKING, VENEZIA**

← Width →

| | 37" | 46" | 55" | 64" | 73" | 78" | 84" | 96" | 109" | 121" | 132" | 144" | 156" | 168" |
|------|-----|-----|-----|-----|-----|------|------|------|------|------|------|------|------|------|
| 36" | 155 | 195 | 213 | 251 | 260 | 307 | 346 | 399 | 542 | 702 | 852 | 907 | 1045 | 1203 |
| 48" | 171 | 204 | 235 | 272 | 294 | 328 | 378 | 429 | 596 | 739 | 926 | 1009 | 1150 | 1343 |
| 60" | 191 | 219 | 254 | 294 | 322 | 350 | 405 | 451 | 614 | 785 | 974 | 1074 | 1287 | 1504 |
| 72" | 204 | 239 | 280 | 332 | 360 | 401 | 462 | 493 | 666 | 866 | 1113 | 1253 | 1504 | 1677 |
| 84" | 240 | 266 | 307 | 360 | 397 | 447 | 493 | 542 | 725 | 934 | 1185 | 1320 | 1614 | 1838 |
| 96" | 263 | 292 | 334 | 382 | 439 | 493 | 547 | 590 | 776 | 1004 | 1281 | 1571 | 1726 | 1907 |
| 108" | 322 | 350 | 405 | 462 | 505 | 586 | 641 | 754 | 836 | 1074 | 1387 | 1721 | 1981 | 2204 |
| 120" | 367 | 399 | 462 | 507 | 586 | 655 | 725 | 836 | 934 | 1158 | 1546 | 1894 | 2170 | 2422 |
| 132" | 403 | 443 | 511 | 561 | 642 | 719 | 798 | 913 | 1019 | 1250 | 1686 | 2069 | 2361 | 2631 |
| 144" | 442 | 485 | 562 | 616 | 700 | 781 | 870 | 991 | 1104 | 1342 | 1828 | 2244 | 2550 | 2840 |
| 156" | 480 | 529 | 614 | 671 | 758 | 845 | 942 | 1068 | 1190 | 1431 | 1968 | 2418 | 2742 | 3048 |
| 168" | 518 | 572 | 664 | 725 | 814 | 909 | 1016 | 1144 | 1273 | 1523 | 2110 | 2594 | 2932 | 3259 |
| 180" | 556 | 615 | 715 | 779 | 871 | 971 | 1086 | 1224 | 1359 | 1614 | 2249 | 2770 | 3122 | 3467 |
| 192" | 594 | 657 | 765 | 834 | 928 | 1036 | 1158 | 1301 | 1443 | 1706 | 2392 | 2942 | 3312 | 3677 |

↑ Height ↓

Longer sizes are available with some limitations, contact customer service for pricing and information

For more Options please see pages 14-20

Prices subject to change without notice

PRICE CHARTS 5 & 6

PRICE CHART 5

PHIFER SHEERWEAVE® 2000, 2390, 2410, 2703, 2705, 4000, 4500, 7200R, 7500, 7650, 7850, SUNTEX 95, MERMET® E SCREEN 3%, M SCREEN DECO 3% & 5%, M SCREEN 3%, S SCREEN 4%, T SCREEN 3%, T SCREEN DECO 3% & 5%, AUTOMATED MOTORIZED SHADES LINEN LOOK B/O, MAMBO, ORIENT B/O FR

← Width →

| | 37" | 46" | 55" | 64" | 73" | 78" | 84" | 96" | 109" | 121" | 132" | 144" | 156" | 168" |
|------|-----|-----|-----|-----|-----|------|------|------|------|------|------|------|------|------|
| 36" | 171 | 216 | 236 | 277 | 291 | 371 | 385 | 463 | 606 | 782 | 951 | 1035 | 1174 | 1354 |
| 48" | 191 | 228 | 260 | 303 | 331 | 417 | 456 | 491 | 664 | 822 | 1021 | 1142 | 1313 | 1516 |
| 60" | 207 | 241 | 285 | 323 | 356 | 448 | 499 | 521 | 686 | 869 | 1092 | 1218 | 1455 | 1697 |
| 72" | 228 | 266 | 314 | 370 | 399 | 491 | 513 | 556 | 748 | 951 | 1231 | 1412 | 1693 | 1888 |
| 84" | 266 | 294 | 342 | 400 | 443 | 547 | 558 | 616 | 812 | 1048 | 1325 | 1511 | 1845 | 2070 |
| 96" | 294 | 329 | 375 | 428 | 491 | 604 | 614 | 666 | 869 | 1124 | 1412 | 1749 | 1987 | 2153 |
| 108" | 342 | 374 | 427 | 513 | 560 | 666 | 681 | 787 | 893 | 1203 | 1464 | 1851 | 2145 | 2384 |
| 120" | 389 | 425 | 513 | 540 | 614 | 766 | 787 | 880 | 983 | 1286 | 1639 | 2024 | 2357 | 2610 |
| 132" | 434 | 472 | 569 | 600 | 675 | 840 | 871 | 970 | 1082 | 1388 | 1799 | 2222 | 2575 | 2847 |
| 144" | 477 | 520 | 624 | 660 | 740 | 913 | 953 | 1061 | 1180 | 1492 | 1961 | 2418 | 2792 | 3085 |
| 156" | 519 | 569 | 678 | 720 | 802 | 988 | 1037 | 1153 | 1280 | 1593 | 2123 | 2617 | 3012 | 3325 |
| 168" | 562 | 617 | 733 | 778 | 868 | 1060 | 1122 | 1246 | 1380 | 1696 | 2283 | 2814 | 3230 | 3561 |
| 180" | 606 | 665 | 787 | 839 | 929 | 1134 | 1206 | 1335 | 1478 | 1799 | 2442 | 3013 | 3447 | 3801 |
| 192" | 647 | 713 | 842 | 897 | 994 | 1208 | 1288 | 1426 | 1576 | 1902 | 2604 | 3210 | 3666 | 4040 |

Longer sizes are available with some limitations, contact customer service for pricing and information

PRICE CHART 6

PHIFER SHEERWEAVE® 2500, 2701, 4400, 4600, 4650, 4800, 4901, 5000, 7100, 7700R, SUNTEX 90 DESIGN, SUNTEX 97, MERMET® E SCREEN 1%, E SCREEN DECO, M SCREEN 1%, NATTE, S SCREEN 1%, T SCREEN 1%, T SCREEN DECO 1%, AUTOMATED MOTORIZED SHADES BLUES, ECO SILK, FASHION SCREEN, MILAN B/O, REVE, VERONA B/O, VINYL FR, VINYL

← Width →

| | 37" | 46" | 55" | 64" | 73" | 78" | 84" | 96" | 109" | 121" | 132" | 144" | 156" | 168" |
|------|-----|-----|-----|-----|------|------|------|------|------|------|------|------|------|------|
| 36" | 180 | 224 | 247 | 290 | 301 | 374 | 400 | 485 | 628 | 814 | 994 | 1093 | 1240 | 1417 |
| 48" | 198 | 239 | 273 | 316 | 348 | 434 | 475 | 512 | 693 | 852 | 1065 | 1198 | 1386 | 1599 |
| 60" | 218 | 253 | 296 | 334 | 370 | 471 | 512 | 560 | 718 | 886 | 1134 | 1285 | 1532 | 1785 |
| 72" | 250 | 277 | 329 | 388 | 415 | 507 | 536 | 601 | 779 | 994 | 1278 | 1493 | 1785 | 1991 |
| 84" | 277 | 308 | 357 | 415 | 458 | 579 | 624 | 666 | 849 | 1093 | 1381 | 1599 | 1943 | 2184 |
| 96" | 308 | 343 | 393 | 448 | 511 | 614 | 639 | 721 | 904 | 1159 | 1479 | 1832 | 2105 | 2264 |
| 108" | 374 | 408 | 468 | 533 | 585 | 715 | 735 | 840 | 965 | 1252 | 1599 | 2037 | 2371 | 2651 |
| 120" | 425 | 465 | 533 | 596 | 664 | 814 | 854 | 933 | 1065 | 1331 | 1799 | 2238 | 2610 | 2877 |
| 132" | 471 | 513 | 589 | 657 | 733 | 891 | 942 | 1031 | 1172 | 1444 | 1963 | 2446 | 2841 | 3125 |
| 144" | 516 | 565 | 645 | 722 | 801 | 970 | 1030 | 1132 | 1278 | 1557 | 2129 | 2654 | 3072 | 3374 |
| 156" | 561 | 616 | 701 | 785 | 870 | 1048 | 1119 | 1230 | 1386 | 1670 | 2293 | 2860 | 3305 | 3625 |
| 168" | 607 | 666 | 758 | 849 | 938 | 1129 | 1209 | 1328 | 1493 | 1782 | 2456 | 3068 | 3539 | 3876 |
| 180" | 653 | 718 | 813 | 911 | 1007 | 1208 | 1296 | 1426 | 1599 | 1897 | 2623 | 3276 | 3770 | 4124 |
| 192" | 699 | 767 | 869 | 974 | 1075 | 1286 | 1386 | 1525 | 1705 | 2010 | 2788 | 3483 | 4002 | 4374 |

Longer sizes are available with some limitations, contact customer service for pricing and information

For more Options please see pages 14-20

Prices subject to change without notice

PRICE CHARTS 7 & 8

PRICE CHART 7

PHIFER SHEERWEAVE °7450, 7600, 7800, INFINITY, 5%,
MERMET ° AVILA TWILIGHT FR, E SCREEN KOOL BLACK 5%, T SCREEN
 KOOL BLACK, VERONA TWILIGHT
**AUTOMATED MOTORIZED SHADES ECO LUX, LINEN, POMPEI, SATINO,
 SWING, VARESE**

← Width →

| | 37" | 46" | 55" | 64" | 73" | 78" | 84" | 96" | 109" | 121" | 132" | 144" | 156" | 168" |
|------|-----|-----|------|------|------|------|------|------|------|------|------|------|------|------|
| 36" | 206 | 261 | 287 | 337 | 354 | 437 | 469 | 565 | 737 | 952 | 1168 | 1281 | 1426 | 1637 |
| 48" | 224 | 277 | 317 | 369 | 407 | 505 | 553 | 604 | 812 | 994 | 1247 | 1399 | 1595 | 1845 |
| 60" | 253 | 295 | 348 | 393 | 430 | 550 | 604 | 652 | 840 | 1036 | 1329 | 1506 | 1762 | 2056 |
| 72" | 292 | 323 | 384 | 451 | 484 | 594 | 632 | 700 | 914 | 1168 | 1497 | 1750 | 2056 | 2293 |
| 84" | 327 | 359 | 422 | 484 | 537 | 678 | 731 | 782 | 994 | 1281 | 1609 | 1874 | 2238 | 2518 |
| 96" | 359 | 398 | 458 | 524 | 604 | 721 | 751 | 840 | 1061 | 1358 | 1734 | 2141 | 2419 | 2601 |
| 108" | 435 | 477 | 548 | 625 | 683 | 836 | 859 | 981 | 1126 | 1469 | 1874 | 2376 | 2726 | 3046 |
| 120" | 498 | 543 | 625 | 698 | 778 | 952 | 997 | 1092 | 1247 | 1563 | 2097 | 2616 | 3007 | 3298 |
| 132" | 549 | 600 | 686 | 769 | 858 | 1041 | 1098 | 1203 | 1368 | 1697 | 2286 | 2843 | 3270 | 3579 |
| 144" | 601 | 656 | 751 | 844 | 938 | 1131 | 1198 | 1315 | 1491 | 1830 | 2475 | 3072 | 3532 | 3859 |
| 156" | 653 | 713 | 814 | 916 | 1018 | 1218 | 1301 | 1425 | 1611 | 1963 | 2663 | 3301 | 3795 | 4139 |
| 168" | 705 | 769 | 877 | 991 | 1098 | 1306 | 1401 | 1536 | 1733 | 2096 | 2854 | 3533 | 4057 | 4420 |
| 180" | 758 | 829 | 941 | 1064 | 1177 | 1397 | 1504 | 1650 | 1855 | 2229 | 3043 | 3762 | 4318 | 4700 |
| 192" | 809 | 886 | 1005 | 1139 | 1259 | 1484 | 1605 | 1761 | 1977 | 2362 | 3232 | 3991 | 4580 | 4979 |

Longer sizes are available with some limitations, contact customer service for pricing and information

PRICE CHART 8

PHIFER SHEERWEAVE ° 2390+, 2410+, 2500+, 7000, 7400
 INFINITY 1% & 3%
MERMET ° E SCREEN CHROMA 3%, E SCREEN KOOL BLACK 1% & 3%,
 FLOCKE, M SCREEN CHROMA 3%

← Width →

| | 37" | 46" | 55" | 64" | 73" | 78" | 84" | 96" | 109" | 121" | 132" | 144" | 156" | 168" |
|------|-----|------|------|------|------|------|------|------|------|------|------|------|------|------|
| 36" | 228 | 364 | 371 | 439 | 447 | 455 | 616 | 727 | 816 | 952 | 1191 | 1302 | 1469 | 1694 |
| 48" | 261 | 426 | 437 | 503 | 509 | 525 | 661 | 773 | 872 | 1036 | 1273 | 1469 | 1650 | 1888 |
| 60" | 300 | 486 | 499 | 567 | 576 | 596 | 691 | 816 | 964 | 1063 | 1358 | 1568 | 1817 | 2097 |
| 72" | 330 | 551 | 563 | 637 | 641 | 659 | 861 | 928 | 1075 | 1191 | 1537 | 1817 | 2112 | 2320 |
| 84" | 364 | 615 | 633 | 698 | 702 | 728 | 889 | 1038 | 1187 | 1293 | 1678 | 1929 | 2307 | 2573 |
| 96" | 439 | 738 | 754 | 766 | 773 | 799 | 924 | 1114 | 1298 | 1399 | 1789 | 2224 | 2475 | 2657 |
| 108" | 475 | 805 | 817 | 834 | 837 | 869 | 1075 | 1262 | 1407 | 1482 | 1902 | 2448 | 2811 | 3104 |
| 120" | 523 | 844 | 874 | 906 | 915 | 966 | 1171 | 1373 | 1534 | 1678 | 2167 | 2683 | 3076 | 3354 |
| 132" | 578 | 909 | 943 | 982 | 1001 | 1065 | 1275 | 1491 | 1665 | 1815 | 2362 | 2923 | 3343 | 3628 |
| 144" | 633 | 967 | 1009 | 1058 | 1084 | 1167 | 1382 | 1606 | 1797 | 1952 | 2557 | 3162 | 3609 | 3900 |
| 156" | 686 | 1030 | 1077 | 1134 | 1168 | 1267 | 1487 | 1723 | 1926 | 2089 | 2753 | 3400 | 3876 | 4173 |
| 168" | 741 | 1092 | 1144 | 1210 | 1251 | 1367 | 1592 | 1839 | 2057 | 2225 | 2949 | 3637 | 4140 | 4444 |
| 180" | 795 | 1152 | 1212 | 1286 | 1335 | 1467 | 1697 | 1956 | 2187 | 2362 | 3143 | 3877 | 4407 | 4718 |
| 192" | 852 | 1212 | 1280 | 1362 | 1419 | 1568 | 1803 | 2072 | 2318 | 2500 | 3338 | 4114 | 4674 | 4989 |

Longer sizes are available with some limitations, contact customer service for pricing and information

For more Options please see pages 14-20

Prices subject to change without notice

OPTIONS

GALAXY CLUTCHES

The G-200 & G-400 Galaxy clutches use planetary gear technology to lift 24 to 53 lbs with approx. 30% less pull force than a normal R16 or R24 clutch.

Only available with a continuous plastic loop chain

Maximum chain length 144"

Can NOT use stop beads on Galaxy series clutches



G-200 GALAXY CLUTCH - \$60

- 1 1/2" tube: 24 lbs
- 2" tube: 18 lbs



G-400 GALAXY CLUTCH - \$116

- 1 1/2" tube: 53 lbs
- 2" tube: 40 lbs
- 2 1/2" tube: 32 lbs
- 3" tube: 26 lbs

GSA-400 GALAXY SPRING ASSIST CLUTCH - \$245

- 1 1/2" tube: 53 lbs
- 2" tube: 40 lbs
- 2 1/2" tube: 32 lbs
- 3" tube: 26 lbs
- Uses less pull force than a standard G-400 Control
- Minimum width: 125"

INFINITY BRACKETS - \$30

Our Infinity Shade System™ is a sleek, modern, commercial system that has been designed to minimize light gaps and compliment modern decor. The unique, polished Infinity™ bracket features a smooth, flush finish and conceals the appearance of the clutch mechanism perfectly. Available in two sizes and multiple colors, this shade system is ideal for a full range of sizes.

Available in White, Black, Anodized & Chrome

Only compatible with Skyline Clutches and/or Motors with a Skyline adapter.



DUAL SHADE BRACKETS

Skyline Clutch Dual Shade Brackets allow you to mount two separate shades on a single mounting bracket.



- Easier, space saving installation
- Available in Vertical Mount (left) & Offset Mount (right)
- Dual shades can also be used in a 5" fascia
- Dual shade brackets are NOT compatible with all clutch and top treatment options

Note: The length of your shade is limited and based on the width of the shade, the size of the tube and the fabric used. Call for more details.

Prices subject to change without notice

OPTIONS

INTERMEDIATE BRACKET (COUPLER) FOR MANUAL SHADES

An ideal solution for linking multiple shades using one manual control. The slim profile reduces the light gap between shades.

Link up to three roller shades

Also available for fascia and motorized systems

Some size restrictions may apply based upon fabric, shade width, and shade height.

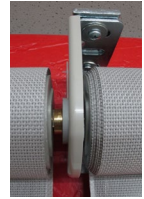

EXTERIOR CLUTCHES

- R16 Exterior Clutch - \$35
- R24 Exterior Clutch - \$60
- Galaxy Exterior Clutch - \$135

The Exterior Clutch system is specifically engineered and warranted for exterior use. Stainless steel springs provide superior performance in most weather conditions. These clutches are perfect for patios, boats, RV's and many other outdoor applications.

The Outdoor Clutch should only be used with fabrics that are approved for exterior use.



CORDLESS SYSTEM

Cordless shade solution for roller shade applications. Smooth shade operation available in 2 styles, a decorative cassette or with a simple top rail system.



Sleek appearance
 Easy installation
 Minimum Width 18"
 Max Width 96" & Max Length 96"
 Safe for children and pets
See Cordless System Price Chart for Pricing

| Width | 37" | 46" | 55" | 64" | 73" | 78" | 84" | 96" | 109" | 121" | 132" | 144" | 156" | 168" |
|----------|-----|-----|-----|-----|-----|-----|-----|-----|---|------|------|------|------|------|
| Cassette | 164 | 202 | 242 | 286 | 321 | 343 | 369 | 422 | Note: Cordless System Max Size is 96" x 72" | | | | | |
| Rail | 89 | 111 | 132 | 153 | 175 | 187 | 201 | 229 | | | | | | |

Note: The length of your shade is limited and based on the width of the shade, the size of the tube and the fabric used. Call for more details.

Prices subject to change without notice

OPTIONS

EXTERIOR CABLE GUIDE SYSTEM

Our heavy duty exterior cable system is designed as a true outdoor use solution for all of your exterior roller shade applications. The shade is firmly secured using stainless steel guide rods attached at the top of the shade and connected to the floor, wall, or bottom frame.

*Outdoor approved (should only be used with exterior fabrics)
Manufactured to stand up to moisture, wind and temperature changes
Not warranted against damage caused by high winds and extreme weather conditions*

Surcharge
\$1080



2 1/2" SIDE CHANNEL

Use to provide light blockage on the sides of your shade. Combine with a Fascia or a Headbox for maximum light blockage

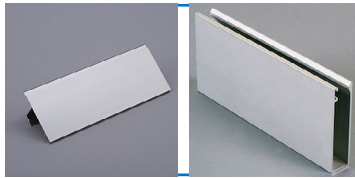

- 2 1/2" 1pc Side Channel w/ felt insert (right) - \$36 per foot of window height
 - Bottom Channel (left) - \$18 per foot of window width
- 2 Piece system snaps together to hide your mounting screws
Channel Colors: White, Anodized & Bronze.
Felt Insert colors: White, Gray & Black.*

MOTORIZATION

The automation of window treatments is the fastest growing segment of the window covering industry. From simple battery operated motors and complete systems that are fully compatible with most automation systems, to motors that are integrated into the window treatment and totally concealed, home or building automation options offer endless decoration possibilities.

See our Motorization Pricing Guide for Prices & Details

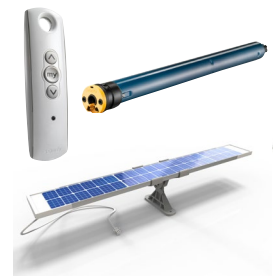

FLAT "L" FASCIA

A simple way to hide your shade along with the mounting brackets. The fascia bracket holds the shade and allows the fascia to snap into place. Available in 3", 4", 5", and 7".

- 3" & 4" Fascia End Caps (Pair): \$15
- 5" Fascia End Caps (Pair): \$30
- 7" Fascia End Caps (Pair): \$43

Colors: White, Vanilla, Anodized, or Bronze (OB End Caps are available for an additional charge) 3" fascia has 2 bracket styles. One for the RollEase® R8 clutch, the other for the R16, please specify when ordering. 4" fascia bracket works for either the RollEase® R16, R24, G200, or G400 clutch. 5" fascia brackets are compatible with Skyline series clutches. 7" fascia brackets work exclusively with motorized shades.



FASCIA PRICING

| | 37" | 46" | 55" | 64" | 73" | 78" | 84" | 96" | 109" | 121" | 132" | 144" | 156" | 168" |
|----|-----|-----|-----|-----|-----|-----|-----|-----|------|------|------|------|------|------|
| 3" | 93 | 111 | 129 | 142 | 154 | 164 | 178 | 198 | 219 | 240 | 261 | 282 | 303 | 339 |
| 4" | 110 | 138 | 151 | 178 | 186 | 201 | 212 | 234 | 259 | 281 | 303 | 328 | 349 | 372 |
| 5" | 170 | 212 | 231 | 268 | 287 | 306 | 326 | 361 | 397 | 432 | 467 | 503 | 539 | 576 |
| 7" | 372 | 415 | 457 | 499 | 542 | 564 | 592 | 648 | 709 | 766 | 816 | 873 | 928 | 985 |

Note: The length of your shade is limited and based on the width of the shade, the size of the tube and the fabric used. Call for more details.

Prices subject to change without notice

OPTIONS

3 1/2" DUST COVER VALANCE

Standard vertical valance with shade fabric insert, supplied with returns.

Some inserts will be two or more pieces depending on the width of the valance and the width of the shade fabric. The fabric can be railroaded but may be a different direction than the shade fabric.



IB SHADE VALANCE

Shade fabric mounted on a wrapped board gives your shade a clean look.

Standard board size is 1" x 1 5/8" and available up to 1" x 4" at no additional charge.

No returns available with this valance.

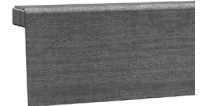

OB SHADE VALANCE

Shade fabric mounted on a wrapped board the same as the IB valance with additional fabric wrapped around the sides as returns. Special hem bar inserts are supplied for a clean corner.

Standard board size is 1" x 2 1/2" and available up to 1" x 4" at no additional charge.

Returns will be the board depth unless otherwise specified.

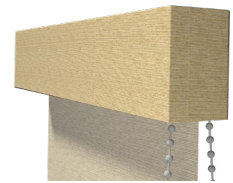

VALANCE PRICING

| Width | 37" | 46" | 55" | 64" | 73" | 78" | 84" | 96" | 109" | 121" | 132" | 144" | 156" | 168" |
|------------------|-----|-----|-----|-----|-----|-----|-----|-----|------|------|------|------|------|------|
| 3 1/2" PVC | 50 | 62 | 71 | 84 | 94 | 102 | 107 | 123 | 141 | 157 | 168 | 184 | 199 | 214 |
| 8" IB | 114 | 142 | 169 | 197 | 224 | 239 | 258 | 294 | 333 | 370 | 404 | 441 | 476 | 512 |
| 8" OB w/ returns | 145 | 179 | 212 | 245 | 281 | 300 | 321 | 368 | 418 | 465 | 504 | 549 | 596 | 641 |

*Valances over 8" in height add \$3 per inch up to a maximum of 12"
Note: For motorization surcharges consult the Motorization Price Guide*

HANGER WITH 3" FLAP

Use when a bottom flap is needed, as in a custom pocket area. The other uses are only limited by your design.

- Hanger & 3" Flap \$24 per ft

No Brackets, Color: White

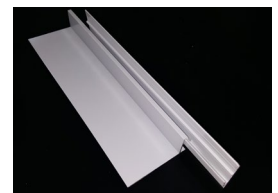

4" & 5" HEAD BOX WITH CLOSURE

For the times when a complete enclosure is needed. Used for drop ceiling applications or when you want to hide the front and back of the complete shade

No Brackets, Color: White

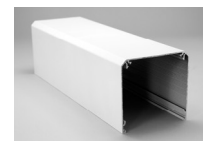

5 INCH POCKET BOX PRICES

| Width | 37" | 46" | 55" | 64" | 73" | 78" | 84" | 96" | 109" | 121" | 132" | 144" | 156" | 168" |
|-------------------|-----|-----|-----|-----|-----|-----|-----|-----|------|------|------|------|------|------|
| Pocket Box | 239 | 297 | 355 | 413 | 470 | 503 | 542 | 618 | 701 | 778 | 849 | 926 | 1003 | 1079 |
| Bottom Closure | 42 | 51 | 61 | 70 | 80 | 85 | 91 | 104 | 118 | 131 | 142 | 156 | 168 | 182 |
| End Caps per pair | 34 | 34 | 34 | 34 | 34 | 34 | 34 | 34 | 34 | 34 | 34 | 34 | 34 | 34 |

Note: The length of your shade is limited and based on the width of the shade, the size of the tube and the fabric used. Call for more details.

Prices subject to change without notice

OPTIONS

CASSETTE OPTIONS

Used to tie the headrail to the fabric using an insert or just a simple way to cover the innerworks of the shade. There are three different options for the cassettes to match and work with the system best for you.

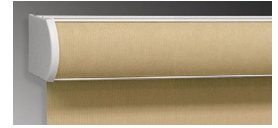

Cassette 120

CASSETTE 100

| Width | 37" | 46" | 55" | 64" | 73" | 78" | 84" | 96" | 109" | 121" | 132" | 144" | 156" | 168" |
|------------|-----|-----|-----|-----|-----|-----|-----|-----|------|------|------|------|------|------|
| w Insert | 141 | 174 | 209 | 241 | 276 | 295 | 317 | 361 | 409 | 480 | 495 | 542 | 584 | 630 |
| w/o Insert | 113 | 151 | 169 | 205 | 218 | 237 | 255 | 280 | 304 | 329 | 355 | 387 | 418 | 449 |

CASSETTE 120

| Width | 37" | 46" | 55" | 64" | 73" | 78" | 84" | 96" | 109" | 121" | 132" | 144" | 156" | 168" |
|------------|-----|-----|-----|-----|-----|-----|-----|-----|------|------|------|------|------|------|
| w Insert | 151 | 185 | 221 | 258 | 294 | 314 | 337 | 385 | 437 | 485 | 529 | 576 | 624 | 671 |
| w/o Insert | 121 | 165 | 186 | 225 | 245 | 266 | 297 | 304 | 329 | 367 | 390 | 416 | 441 | 471 |

Brackets are included in the price. Colors: White, Vanilla, Anodized, Bronze & Black.

SQUARE CASSETTE

| Width | 37" | 46" | 55" | 64" | 73" | 78" | 84" | 96" | 109" | 121" | 132" | 144" | 156" | 168" |
|------------|-----|-----|-----|-----|-----|-----|-----|-----|------|------|------|------|------|------|
| w Insert | 141 | 174 | 209 | 241 | 276 | 295 | 317 | 361 | 409 | 480 | 495 | 542 | 584 | 630 |
| w/o Insert | 113 | 151 | 169 | 205 | 218 | 237 | 255 | 280 | 304 | 329 | 355 | 387 | 418 | 449 |

Colors: White, Vanilla, Anodized, Bronze & Black.

BOTTOM HEM & RAIL OPTIONS

HEAT SEALED HEMBAR*

Aluminum hembar inserted into a fabric hem with standard open ends or with optional sealed ends

**Included In Roller Shade Price*

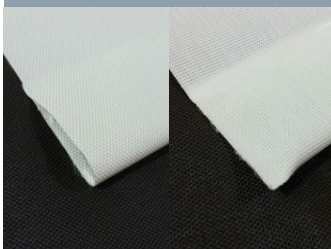

SLIM BOTTOM RAIL

Optional decorative slim profile hembar perfect for tight spaces and shades requiring side rails. Available with or without felt.

Price Chart below



Prices subject to change without notice

OPTIONS

CUSTOM PRINTING

At Automated Motorized Shades® we know that customization is key. Our custom printing services allow interior designers to design custom patterns to match decor. From full bleed images to tiled, decorative patterns, your printing options are endless. Choose from a variety of printable solar screen fabrics to create unique, exclusive shades for your clients.



SPECIFICATIONS & GUIDELINES

- File Types: .AI, .EPS, .JPG, .PDF, .PS, .PSD, .TIF
- Outline all fonts
- Maximum print width 126"
- DPI: 75 minimum, 150 Optimal
- Bleed: .5" per side
- Include .PDF so we can verify your file layout
- Please Call for pricing

FEATURES

- Water Based Latex Inks, the most environmentally conscious printing method available
- Odorless prints are GREENGUARD Children and Schools certified
- Inks are non-flammable and non-combustible
- Up to 1 Hour of Set-Up Time Included in Pricing

*Note: The length of your shade is limited and based on the width of the shade, the size of the tube and the fabric used. Call for more details.
Minimum Printed Shade Order \$200*

PERSONALIZED CONTROLS

Allow Automated Motorized Shades® to customize controls including wall switches and remotes. This added feature allows you to individualize each order for your clients. Whether the controls are bright and colorful for a child's room, or simplistic and modern for a living room, our custom, made-to-order patterns are sure to "wow" your customers.

Please Call for Pricing



Prices subject to change without notice

CHILD SAFETY & WARRANTY

CHILD SAFETY

Every product we send out meets or exceeds the latest safety standards as set forth by the Consumer Product Safety Council and the Window Covering Manufacturers Association. For enhanced safety, Automated Motorized Shades offers cordless and motorized window treatments.

REMEMBER THESE SAFETY RULES...

- For children's bedrooms only install window coverings that are cordless.
- Any window coverings in your home that were made before 2001, should be replaced with today's newer, safer models.
- Do not place furniture near windows that have window coverings with cords.
- Keep all cords out of reach from small children. Do this by securing tasseled pull cords out of reach with a cord cleat, and anchoring continuous-loop cords to the wall with safety devices.
- Always be sure to lock and firmly secure cords in position.
- Products such as Roman or Woven Wood Shades that have accessible back cords, should not be installed within reach of children.

All products come with safety labels attached. This is to help raise awareness of the potential safety risks associated with the products you purchase. If you have any concerns, please do not hesitate to contact us directly. You may also directly contact any of the associations that create the safety standards with any questions or concerns. Child safety is our top priority!

WARRANTY

Automated Motorized Shades guarantees all products manufactured in our facility to be free from defects due to faulty workmanship and/or materials. We are so confident about our quality and dependability that we back our manual shades with a limited lifetime warranty, our motors with a 5 year limited warranty, and our custom printed shades with a 3 year warranty against fading. All warranties are effective from the original invoice date of the product.

This guarantee does not apply to damage to exterior shades caused by high winds and/or extreme weather conditions. Any roller shade or parts which fail due to abuse, accident, theft, alterations, improper use or

installation, or gradual color fading, are also excluded from this warranty.

Automated Motorized Shades reserves the right to inspect products and will replace or repair any product found to be defective as a result of faulty workmanship or materials.

Shipping charges, trip charges and labor costs for measuring and installation and/or removal of old or current products are excluded. This

warranty is available to the original owner/purchaser and is non-transferable. Automated Motorized Shades' warranty is designed to ensure a thoroughly satisfying experience with your window treatment product. Certain restrictions may apply.

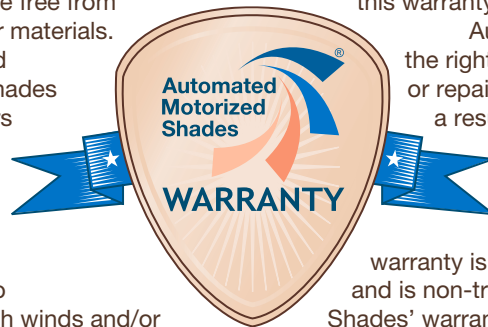



PARALLEL SHADE COLLECTION

PRICING GUIDE

TABLE OF CONTENTS

Overview..... 2

Options..... 3

Fabrics..... 4

Price Charts..... 5-6

 Price Chart 1..... 5

 Price Chart 2..... 5

 Price Chart 3..... 6

 Price Chart 4..... 6

Child Safety & Warranty..... 7

OVERVIEW

DESCRIPTION

An easy to use chain operated clutch control effortlessly slides the opaque and translucent woven stripes past each other. The front layer moves independently of the back allowing the stripes to glide between each other creating an open and closed effect, allowing for limitless light control. The same operation is used to raise or lower the window blind to any height in the window with ease, in the same way a classic roller shade would. Motorization options are also available to compliment the entire Parallel™ shade collection. The exceptional Parallel™ shade collection features sheer metallics, delicate subtle tones and natural wood weave effects, the perfect choice for any room in the home.



OPEN



CLOSED

OPTIONS

CASSETTES

The contemporary style of the Parallel™ Shades is on full display with a Closed Cassette system. Both options conceal the operating mechanism of the shade neatly and stylishly. The new 70mm Cassette adds the flexibility to have the shade roll off either the front or back of the cassette, which allows for more efficient mounting options. All are available with or without a matching fabric insert. The entire cassette line features European influenced designs and colors, including white, black, ivory, brushed aluminum, antique bronze and chrome finishes, all of which are listed on the next page. The possibilities are endless and the colors can be mixed or matched, the choice is yours!



***CLOSED CASSETTE
WITH FABRIC INSERT***



70 MM CASSETTE

BOTTOM RAIL

The Bottom Rail is engineered to self centralize, even if the bar is knocked out of place it will correct itself automatically, preventing any damage to your shade. The enclosed design has an inner rod that prevents light from creeping through in any position to reduce light strike. The bottom rail features the same colors as all head rail colors, which include white, black, ivory, brushed aluminum, antique bronze and chrome finishes, so that you can mix or match your color scheme.



BOTTOM RAIL

FABRICS

| Name | Price Chart | Maximum Fabric Width |
|--------------------|-------------|----------------------|
| Blues | 3 | 110" |
| CScreen | 4 | 110" |
| Dixie | 4 | 110" |
| DixieXL | 4 | 110" |
| Eclisse Fusion | 4 | 110" |
| Funk | 2 | 110" |
| Fusion | 4 | 110" |
| Jazz | 2 | 110" |
| Jive | 2 | 110" |
| Linea | 4 | 110" |
| Linen | 3 | 110" |
| Lounge | 3 | 110" |
| Mambo | 3 | 110" |
| Merengue | 3 | 110" |
| Reve | 3 | 110" |
| Rumba | 2 | 110" |
| Seasons | 1 | 110" |
| Soul | 3 | 110" |
| Swing | 4 | 110" |
| Tango | 4 | 110" |
| Twinlight C-Screen | 4 | 110" |
| Twist | 4 | 110" |
| Woodsheer | 2 | 110" |

PRICE CHARTS 1 & 2

PRICE CHART 1

SEASONS

| | | ← Width → | | | | | | | | | | | | | | |
|------------|------|-----------|-----|------|------|------|------|------|------|------|------|------|------|------|------|------|
| | | 24" | 30" | 36" | 42" | 48" | 54" | 60" | 66" | 72" | 78" | 84" | 90" | 96" | 102" | 110" |
| ↑ Height ↓ | 36" | 336 | 378 | 424 | 462 | 508 | 551 | 592 | 685 | 637 | 727 | 753 | 790 | 829 | 865 | 905 |
| | 42" | 355 | 399 | 445 | 493 | 541 | 588 | 634 | 730 | 682 | 775 | 802 | 844 | 887 | 928 | 970 |
| | 48" | 376 | 424 | 475 | 523 | 574 | 624 | 682 | 779 | 732 | 826 | 853 | 901 | 945 | 994 | 1039 |
| | 54" | 391 | 445 | 499 | 556 | 609 | 667 | 727 | 826 | 787 | 874 | 907 | 958 | 1012 | 1066 | 1120 |
| | 60" | 409 | 470 | 525 | 586 | 642 | 709 | 772 | 871 | 834 | 928 | 963 | 1021 | 1081 | 1138 | 1195 |
| | 66" | 427 | 493 | 556 | 616 | 682 | 751 | 821 | 915 | 889 | 982 | 1023 | 1087 | 1147 | 1210 | 1270 |
| | 72" | 448 | 517 | 583 | 649 | 721 | 796 | 871 | 970 | 942 | 1039 | 1081 | 1150 | 1215 | 1286 | 1352 |
| | 78" | 460 | 535 | 604 | 679 | 753 | 832 | 907 | 1015 | 987 | 1089 | 1138 | 1207 | 1278 | 1348 | 1417 |
| | 84" | 478 | 556 | 628 | 712 | 793 | 874 | 958 | 1069 | 1041 | 1147 | 1197 | 1273 | 1344 | 1420 | 1496 |
| | 90" | 502 | 577 | 658 | 745 | 832 | 922 | 1005 | 1120 | 1097 | 1201 | 1258 | 1336 | 1415 | 1496 | 1572 |
| | 96" | 517 | 601 | 685 | 775 | 869 | 958 | 1048 | 1170 | 1142 | 1258 | 1312 | 1396 | 1480 | 1564 | 1645 |
| | 102" | 592 | 685 | 779 | 879 | 976 | 1063 | 1188 | 1286 | 1304 | 1372 | 1428 | 1510 | 1594 | 1675 | 1756 |
| | 108" | 624 | 727 | 824 | 928 | 1026 | 1123 | 1251 | 1354 | 1375 | 1447 | 1504 | 1591 | 1678 | 1769 | 1855 |
| | 114" | 655 | 761 | 861 | 973 | 1071 | 1180 | 1312 | 1420 | 1443 | 1516 | 1577 | 1669 | 1764 | 1858 | 1951 |
| 120" | 685 | 796 | 905 | 1021 | 1123 | 1236 | 1375 | 1486 | 1514 | 1587 | 1648 | 1747 | 1850 | 1951 | 2050 | |

All Sizes can be made with the 70mm Cassette System

PRICE CHART 2

WOODSHEER, RUMBA, FUNK, JAZZ, JIVE

| | | ← Width → | | | | | | | | | | | | | | |
|------------|------|-----------|-----|------|------|------|------|------|------|------|------|------|------|------|------|------|
| | | 24" | 30" | 36" | 42" | 48" | 54" | 60" | 66" | 72" | 78" | 84" | 90" | 96" | 102" | 110" |
| ↑ Height ↓ | 36" | 359 | 404 | 452 | 493 | 538 | 586 | 628 | 677 | 739 | 772 | 808 | 850 | 889 | 931 | 970 |
| | 42" | 378 | 424 | 475 | 525 | 574 | 624 | 672 | 724 | 790 | 824 | 861 | 907 | 952 | 997 | 1041 |
| | 48' | 399 | 452 | 506 | 556 | 609 | 664 | 724 | 779 | 842 | 877 | 915 | 968 | 1015 | 1066 | 1115 |
| | 54' | 417 | 475 | 533 | 588 | 649 | 709 | 772 | 838 | 892 | 931 | 973 | 1031 | 1087 | 1144 | 1204 |
| | 60' | 436 | 499 | 559 | 622 | 685 | 751 | 821 | 889 | 942 | 985 | 1033 | 1097 | 1160 | 1223 | 1281 |
| | 66' | 454 | 523 | 588 | 655 | 724 | 798 | 874 | 942 | 991 | 1041 | 1099 | 1168 | 1231 | 1299 | 1367 |
| | 72' | 475 | 548 | 619 | 690 | 766 | 847 | 924 | 1003 | 1048 | 1102 | 1162 | 1233 | 1306 | 1378 | 1451 |
| | 78' | 490 | 569 | 642 | 721 | 798 | 887 | 963 | 1048 | 1097 | 1155 | 1223 | 1296 | 1372 | 1447 | 1522 |
| | 84' | 508 | 588 | 667 | 758 | 842 | 928 | 1018 | 1105 | 1152 | 1215 | 1286 | 1367 | 1443 | 1524 | 1603 |
| | 90' | 533 | 614 | 700 | 790 | 882 | 978 | 1069 | 1162 | 1210 | 1276 | 1352 | 1435 | 1519 | 1603 | 1690 |
| | 96' | 551 | 637 | 727 | 824 | 922 | 1018 | 1115 | 1213 | 1264 | 1332 | 1411 | 1501 | 1587 | 1678 | 1769 |
| | 102' | 628 | 727 | 829 | 937 | 1036 | 1129 | 1260 | 1384 | 1388 | 1456 | 1533 | 1624 | 1711 | 1797 | 1887 |
| | 108' | 664 | 769 | 874 | 987 | 1089 | 1192 | 1330 | 1461 | 1461 | 1533 | 1614 | 1711 | 1801 | 1897 | 1993 |
| | 114' | 697 | 808 | 915 | 1036 | 1142 | 1251 | 1396 | 1537 | 1537 | 1609 | 1693 | 1792 | 1894 | 1993 | 2095 |
| 120' | 730 | 847 | 960 | 1087 | 1192 | 1312 | 1461 | 1609 | 1609 | 1688 | 1771 | 1878 | 1984 | 2092 | 2196 | |

All Sizes can be made with the 70mm Cassette System

Prices subject to change without notice

PRICE CHARTS 3 & 4

PRICE CHART 3

SOUL, REVE, LOUNGE, BLUES, MERENGUE, MAMBO, LINEN

| | ← Width → | | | | | | | | | | | | | | |
|------|-----------|-----|------|------|------|------|------|------|------|------|------|------|------|------|------|
| | 24" | 30" | 36" | 42" | 48" | 54" | 60" | 66" | 72" | 78" | 84" | 90" | 96" | 102" | 110" |
| 36" | 378 | 427 | 478 | 523 | 571 | 622 | 664 | 714 | 796 | 816 | 861 | 907 | 952 | 997 | 1039 |
| 42 | 399 | 452 | 502 | 556 | 609 | 664 | 714 | 766 | 847 | 871 | 922 | 970 | 1018 | 1063 | 1115 |
| 48' | 424 | 478 | 535 | 588 | 646 | 703 | 766 | 826 | 907 | 928 | 978 | 1033 | 1087 | 1142 | 1192 |
| 54' | 441 | 502 | 565 | 624 | 687 | 748 | 816 | 887 | 960 | 985 | 1039 | 1102 | 1162 | 1225 | 1286 |
| 60' | 460 | 529 | 592 | 658 | 724 | 796 | 869 | 940 | 1012 | 1041 | 1105 | 1170 | 1241 | 1306 | 1372 |
| 66' | 480 | 556 | 624 | 695 | 766 | 844 | 924 | 1000 | 1066 | 1102 | 1178 | 1249 | 1318 | 1388 | 1459 |
| 72' | 506 | 580 | 655 | 730 | 811 | 895 | 978 | 1061 | 1126 | 1165 | 1243 | 1321 | 1396 | 1474 | 1551 |
| 78' | 517 | 601 | 679 | 763 | 847 | 937 | 1021 | 1111 | 1180 | 1223 | 1306 | 1388 | 1465 | 1546 | 1627 |
| 84' | 538 | 624 | 705 | 802 | 892 | 982 | 1079 | 1170 | 1241 | 1286 | 1375 | 1459 | 1546 | 1630 | 1714 |
| 90' | 561 | 649 | 739 | 838 | 937 | 1036 | 1132 | 1231 | 1299 | 1352 | 1443 | 1533 | 1624 | 1714 | 1804 |
| 96' | 583 | 677 | 769 | 871 | 976 | 1079 | 1180 | 1281 | 1360 | 1411 | 1506 | 1603 | 1698 | 1792 | 1887 |
| 102' | 664 | 769 | 877 | 991 | 1099 | 1197 | 1336 | 1468 | 1491 | 1540 | 1640 | 1735 | 1827 | 1923 | 2020 |
| 108' | 703 | 814 | 928 | 1045 | 1152 | 1260 | 1411 | 1549 | 1572 | 1624 | 1726 | 1827 | 1926 | 2029 | 2128 |
| 114' | 735 | 853 | 970 | 1099 | 1207 | 1323 | 1477 | 1627 | 1651 | 1701 | 1810 | 1918 | 2023 | 2128 | 2236 |
| 120' | 772 | 895 | 1018 | 1150 | 1260 | 1390 | 1546 | 1706 | 1729 | 1787 | 1894 | 2008 | 2123 | 2233 | 2343 |

All Sizes can be made with the 70mm Cassette System

PRICE CHART 4

DIXIE, DIXIE XL, SWING, TANGO, LINEA, TWIST

| | ← Width → | | | | | | | | | | | | | | |
|------|-----------|-----|------|------|------|------|------|------|------|------|------|------|------|------|------|
| | 24" | 30" | 36" | 42" | 48" | 54" | 60" | 66" | 72" | 78" | 84" | 90" | 96" | 102" | 110" |
| 36" | 398 | 450 | 506 | 554 | 603 | 658 | 700 | 752 | 854 | 861 | 915 | 962 | 1015 | 1062 | 1109 |
| 42 | 422 | 479 | 529 | 586 | 646 | 703 | 756 | 809 | 905 | 918 | 983 | 1033 | 1084 | 1129 | 1187 |
| 48' | 447 | 506 | 564 | 621 | 682 | 743 | 809 | 873 | 972 | 978 | 1041 | 1098 | 1161 | 1216 | 1270 |
| 54' | 465 | 529 | 598 | 661 | 726 | 787 | 861 | 935 | 1029 | 1039 | 1105 | 1174 | 1235 | 1306 | 1367 |
| 60' | 486 | 559 | 624 | 695 | 762 | 842 | 917 | 992 | 1082 | 1098 | 1179 | 1245 | 1321 | 1389 | 1461 |
| 66' | 508 | 588 | 661 | 733 | 809 | 889 | 975 | 1057 | 1142 | 1163 | 1256 | 1330 | 1404 | 1475 | 1552 |
| 72' | 536 | 613 | 690 | 769 | 856 | 943 | 1033 | 1118 | 1203 | 1228 | 1323 | 1409 | 1487 | 1569 | 1652 |
| 78' | 543 | 634 | 714 | 805 | 895 | 987 | 1079 | 1174 | 1263 | 1289 | 1389 | 1479 | 1559 | 1645 | 1731 |
| 84' | 569 | 661 | 744 | 847 | 942 | 1036 | 1139 | 1235 | 1328 | 1355 | 1465 | 1552 | 1648 | 1736 | 1825 |
| 90' | 591 | 685 | 779 | 887 | 991 | 1094 | 1195 | 1300 | 1390 | 1426 | 1536 | 1632 | 1728 | 1825 | 1919 |
| 96' | 616 | 716 | 812 | 918 | 1031 | 1139 | 1245 | 1351 | 1457 | 1489 | 1602 | 1706 | 1810 | 1905 | 2006 |
| 102' | 700 | 812 | 926 | 1045 | 1162 | 1266 | 1411 | 1552 | 1596 | 1625 | 1745 | 1845 | 1945 | 2049 | 2153 |
| 108' | 743 | 859 | 982 | 1102 | 1215 | 1329 | 1491 | 1636 | 1684 | 1713 | 1837 | 1945 | 2052 | 2161 | 2262 |
| 114' | 775 | 897 | 1023 | 1162 | 1272 | 1395 | 1559 | 1716 | 1766 | 1795 | 1926 | 2044 | 2153 | 2262 | 2376 |
| 120' | 813 | 943 | 1075 | 1213 | 1329 | 1467 | 1630 | 1802 | 1850 | 1885 | 2018 | 2137 | 2260 | 2372 | 2491 |

All Sizes can be made with the 70mm Cassette System

Prices subject to change without notice

CHILD SAFETY & WARRANTY

CHILD SAFETY

Every product we send out meets or exceeds the latest safety standards as set forth by the Consumer Product Safety Council and the Window Covering Manufacturers Association. For enhanced safety, Automated Motorized Shades offers cordless and motorized window treatments.

REMEMBER THESE SAFETY RULES...

- For children's bedrooms only install window coverings that are cordless.
- Any window coverings in your home that were made before 2001, should be replaced with today's newer, safer models.
- Do not place furniture near windows that have window coverings with cords.
- Keep all cords out of reach from small children. Do this by securing tasseled pull cords out of reach with a cord cleat, and anchoring continuous-loop cords to the wall with safety devices.
- Always be sure to lock and firmly secure cords in position.
- Products such as Roman or Woven Wood Shades that have accessible back cords, should not be installed within reach of children.

All products come with safety labels attached. This is to help raise awareness of the potential safety risks associated with the products you purchase. If you have any concerns, please do not hesitate to contact us directly. You may also directly contact any of the associations that create the safety standards with any questions or concerns. Child safety is our top priority!

WARRANTY

Automated Motorized Shades guarantees all products manufactured in our facility to be free from defects due to faulty workmanship and/or materials. We are so confident about our quality and dependability that we back our manual shades with a limited lifetime warranty, our motors with a 5 year limited warranty, and our custom printed shades with a 3 year warranty against fading. All warranties are effective from the original invoice date of the product.

This guarantee does not apply to damage to exterior shades caused by high winds and/or extreme weather conditions. Any roller shade or parts which fail due to abuse, accident, theft, alterations, improper use or

installation, or gradual color fading, are also excluded from this warranty.

Automated Motorized Shades reserves the right to inspect products and will replace or repair any product found to be defective as a result of faulty workmanship or materials.

Shipping charges, trip charges and labor costs for measuring and installation and/or removal of old or current products are excluded. This

warranty is available to the original owner/purchaser and is non-transferable. Automated Motorized Shades' warranty is designed to ensure a thoroughly satisfying experience with your window treatment product. Certain restrictions may apply.

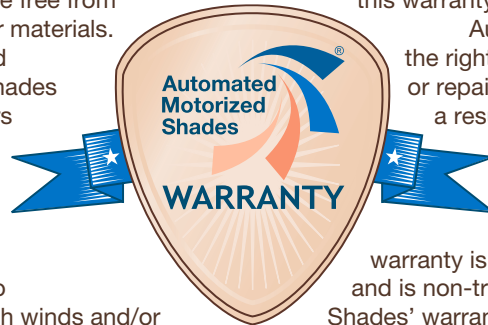



HORIZONTAL SHEER COLLECTION

PRICING GUIDE

TABLE OF CONTENTS

| | |
|---|-----|
| Features & Benefits | 1 |
| Design & Operation | 2-3 |
| Measuring Instructions | 4 |
| Product Specifications | 5 |
| Price Charts..... | 6-8 |
| Price Chart 1 2" Light Filtering..... | 6 |
| Price Chart 2 2" Room Darkening | 6 |
| Price Chart 3 2 ½" Light Filtering..... | 7 |
| Price Chart 4 2 ½" Room Darkening | 7 |
| Price Chart 5 3" Light Filtering..... | 8 |
| Price Chart 6 3" Room Darkening | 8 |
| Child Safety & Warranty | 9 |

FEATURES & BENEFITS

- Horizontal fabric vanes floating between two layers of soft, knitted fabric sheers, that soften your view outside.
- Sheer fabric vane colors are featured between two layers of white sheer fabric with the exception of Pearl Essence, color #3001, which features sheer fabric that is matched to the Pearl color of the vane creating a rich tone-on-tone appearance.
- Available in widths up to 114" and drops up to 120" that provide an elegant solution for covering larger window openings.
- Vanes glide smoothly from open to closed, to virtually, "out of sight."
- The Continuous Cord System provides five distinct vane positions for endless combinations of privacy, view, and light control.
- Partially raise the shading with the fabric vanes in the open, "view-through" position so that you can keep your view and still enjoy the beauty of the sheer horizontal vanes.
- Two different color coordinated headrail styles are available.
- A smaller width deduction provides minimal light leakage on shading sides and above the headrail for increased privacy.
- Easy to install hardware and brackets allows for effortless installations and easy removal for cleaning.
- Durable fabrics that can be ultrasonically or traditionally cleaned to keep shades bright and beautiful.
- Lifetime Limited Warranty as a commitment to your satisfaction.
- Sheer fabrics may be processed with a topical treatment to resist flames and to adhere to flammability codes. For more information, contact Automated Motorized Shades.

DESIGN & OPERATION

FABRIC COLLECTIONS

Sheer shades are available with two different fabric types. Light filtering fabric that gently diffuses light and room darkening fabric that casts deep room darkening shadows. Please note that room darkening materials are not blackout fabrics.

INSIDE MOUNT

Sheer shades feature a Continuous Cord System. The Continuous Cord System provides the ability to manipulate the shade into various viewing position using just one control. From the closed and retracted position (fabric inside the headrail), lower the fabric by pulling down on the loop cord until you reach the desired shading position. Once lowered completely to the window sill, continuing to pull the cord in the same direction will open the horizontal fabric vanes, offering spectacular views to the outside. Continuing to pull the cord in the same direction will lift the shade while still in the view-through mode. To retract the shading, simply pull down on the cord in the opposite direction until the shade reaches the desired fabric position.

VIEWING OPTIONS

The Continuous Cord System provides a number of positioning options for controlling light and privacy. This allows for more precise control of visibility through the shades as the vanes are tilted to their maximum open position. The following five positions can be obtained when using standard shading operation when viewing the shading at eye level.

CLOSED TOP, OPEN BOTTOM

By partially lowering the shade from the fully raised position, the upper portion of your window will become semi-opaque while allowing a clear view below.

FULLY PRIVATE

When lowered completely, the shade provides maximum privacy and softly diffuses light.

PARTIALLY OPEN

By adjusting the continuous cord you can gradually increase the level of light and allow varying levels of “view-through.”

VIEW-THROUGH WHEN LOWERED

Completely opening the vanes in the down position provides a softened, veiled view to the outside.

VIEW-THROUGH WHEN RAISED

From the open or view-through position, continuing to pull down on the cord will raise the fabric allowing a clear view outside from below, and a veiled view above. This exclusive feature allows the shade to be raised up to 24” in this mode.

VANE CLOSURE



VANE CLOSURE

Sheer shade fabric vanes overlap and provide privacy when closed. However, the inherent nature of the fabric will cause a slight increase in the distance from the front sheer to back sheer as you move further down the shade. These vanes do not form a perfect seal against light leakage which is most visible toward the bottom of the shade.

Vane closure is measured as the distance between the front and rear fabric sheers 6” up from the lowest point of the bottom rail, with the shade fully lowered and the vanes closed. For sheer shades, the maximum distance from the front sheer to the back sheer when closed is 1/8”. On room darkening fabrics, the distance is 5/8”. Vane closure on all 3” fabrics will have a distance of 1”.

SIDE-BY-SIDE ALIGNMENT

When sheer shades are installed side-by-side, vane alignment can be guaranteed within 1/4” only if:

- The shades are the same color and ordered at the same time.
- Side-by-side lineup is specified when the order is placed.

DESIGN & OPERATION

VANE OPENING

Vanes on the three styles of sheer shade fabrics open to slightly different degrees. Consequently, there are variations in visibility through the shades when the vanes are tilted to their maximum open positions. The variations between the products are shown in the vane illustrations. The illustration represents looking through the shading $\frac{1}{4}$ " of the way up from the bottom.

LEVELING SHEER SHADES

Sheer shades are leveled and weighted in the factory. When installed level, the fabric will not skew when raised. If the headrail is not installed level, skewing can occur that can damage the edge of the fabric. Be sure to follow the installation instructions carefully to ensure correct and balanced operation.

HARDWARE

HOLD DOWN BRACKETS

Hold down brackets are made of a clear plastic which fit into holes in the end cap of the bottom rail. Hold downs are generally used to secure the bottom of the sheer shade to prevent swaying when mounted on a door.

EXTENSION BRACKETS

Extension or "L" brackets are available which can be used to project the back of the shade $4\frac{1}{4}$ " from the mounting surface.

SPACER BLOCKS

Spacer blocks project the shade $\frac{3}{8}$ " from the mounting surface. Use spacer blocks to obtain clearance when obstructions, such as window cranks or door handles, obstruct the movement of the shade.

CORD TENSIONER

The cord tensioner keeps the cord taut to prevent children and pets from entangling and subsequently injuring themselves. Cord tensioners must be used for this product to comply with the Consumer Product Safety Commission (CPSC) Child Safety guidelines.

INSTALLATION CONSIDERATIONS

After installation, windows that are not square and level may cause the shadings to shift to one side as it rolls up, requiring adjustment of the headrail. This shifting can cause fraying and/or make the shade appear crooked. Shims can be used to lower the shade and level the headrail. Shims are available by request at no additional charge. Please specify at time of

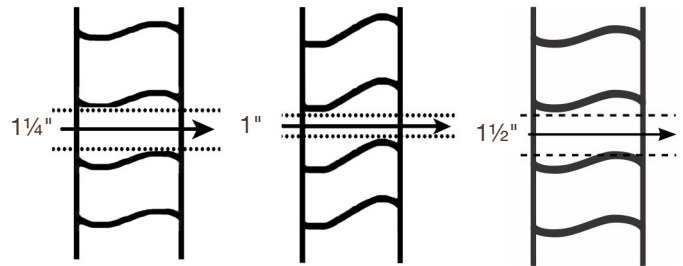

HEIGHT CONSIDERATIONS

Automated Motorized Shades will fabricate your sheer shade to the exact height ordered. Exact height is calculated from the top of the headrail to the bottom of the shade when the vanes are in the open (or view-through) position. When the vanes are rotated to the closed position, the shade will become $\frac{3}{8}$ " longer.

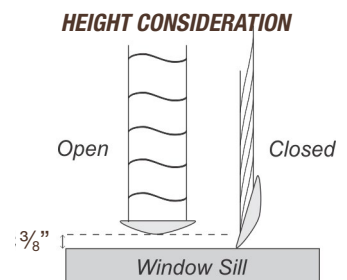

When closed on an inside mount, a slight puckering may occur on the bottom of the sheer due to contact with the sill. To compensate, slightly raise the shading until the rail begins to lift off the window sill. If preferred, the shade can be ordered $\frac{3}{8}$ " less than the measured height of the window opening. In this case, the bottom rail will be positioned $\frac{3}{8}$ " above the sill when the vanes are in the open position. Rotating the vanes closed will cause the bottom rail to touch the window sill, effectively removing any open space.

MEASURING INSTRUCTIONS

MEASUREMENTS

Precise width and height measurements are critical. Fabric width cannot be altered after the shading is fabricated. Please use a metal tape measure for accuracy.

The headrail must be installed perfectly level and evenly to ensure smooth operation. On an inside mount, it is recommended that you check to see that the mounting surface is level and consistent. If shims are necessary please specify at time of ordering.

INSIDE MOUNT

Measure across the width of your window opening in three different places - top, middle and bottom. Measurements should be taken within the window jamb. Provide the smallest of the three measurements and be exact. Automated Motorized Shades will make the necessary deductions to fit the window

opening.

Measure the height of the window opening from the underside of the soffit to the surface of the window sill in two places - use the smallest of these two measurements.

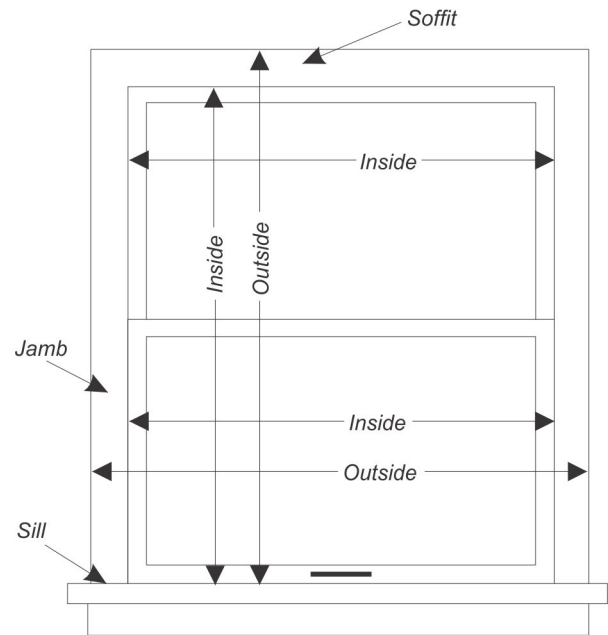

SIDE MOUNT

Sheer shades may be side mounted using "L" brackets. For side mounts, follow the instructions for inside mounts. An additional 1/2" will be taken off the standard inside mount deduction to allow room for the "L" brackets.

The maximum shade width utilizing the side mount option is 48".

OUTSIDE MOUNT

Measure the exact width and height of the area to be covered. On the width, allow at least 1-1/2" of an overlap on each side. An overlap of 3" on each side is recommended.

Be sure to take into consideration any obstructions such as window trim, molding, locks and window cranks.

PRODUCT SPECIFICATIONS

PRIVACY & LIGHT CONTROL OPTIONS

Aluminum cassette with a color coordinated fabric insert

| | |
|---|--------|
| Minimum Flush Inside Mount with Install Brackets..... | 3 1/8" |
| Minimum Shallow Mounting Surface | 3/4" |
| Minimum Side Mounting Surface..... | 1 1/4" |
| Maximum Shade Width Side Mount | 48" |
| Minimum Outside Mounting Surface..... | 3/4" |

CORD INFORMATION

Braided polyester cord styles will measure the height indicated below unless otherwise specified.

| SHADE HEIGHT | SHADE HEIGHT |
|--------------|--------------|
| 12" - 40" | 2' (24") |
| 40" - 52" | 3' (36") |
| 52" - 72" | 4' (48") |
| 72" - 96" | 5' (60") |
| 96" - 120" | 6' (72") |

MAXIMUM CORD HEIGHTS

- Polyester cord - 15 feet
- Cord can be ordered in custom lengths in one foot increments from 2' to 15'

CORDLESS OPTIONS

Strap available in black or white only

| | |
|-------------------|-----------|
| Minimum Size..... | 20" x 20" |
| Maximum Size..... | 84" x 84" |

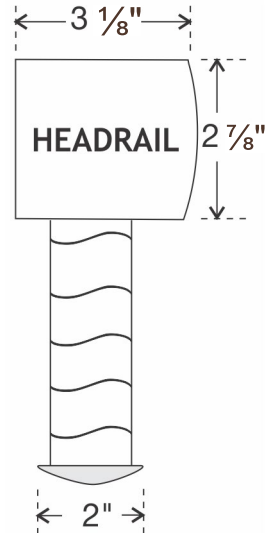

FINISHED DIMENSIONS

Once ordered and manufactured, the width of the fabric cannot be altered. Your fabricator makes deductions to the width of Sheer Shadings depending on the type of mounting indicated. For all mounting types, fabric will measure exactly the height ordered when the vanes are in the open or "view-through" position.

INSIDE MOUNT

- Headrail will measure ordered width minus 3/16"
- Fabric will measure ordered width minus 1 1/8"

SIDE (END) MOUNT

- Headrail will measure ordered width minus 11/16"
- Fabric will measure ordered width minus 1 1/8"

OUTSIDE MOUNT

- Headrail will measure ordered width plus 3/16"
- Fabric will measure ordered width minus 3/4"

EXACT (ENDCAP TO ENDCAP)

- Headrail will measure ordered width
- Fabric will measure ordered width minus 15/16"

Headrail measurements include endcaps. Width and width measurements may vary +/- 1/8".

2" VANE PRICE CHARTS 1-2

PRICE CHART 1

LIGHT FILTERING

| | | ← Width → | | | | | | | | | | | | |
|------------------|------|-----------|------|------|------|------|------|------|------|------|------|------|------|------|
| | | 24" | 30" | 36" | 42" | 48" | 54" | 60" | 66" | 72" | 84" | 96" | 108" | 120" |
| ↑ Height ↓ | 36" | 666 | 747 | 835 | 913 | 1000 | 1086 | 1166 | 1253 | 1467 | 1646 | 1815 | 2205 | 2595 |
| | 42" | 702 | 790 | 878 | 977 | 1069 | 1164 | 1253 | 1344 | 1564 | 1758 | 1941 | 2367 | 2793 |
| | 48" | 743 | 838 | 940 | 1033 | 1132 | 1235 | 1340 | 1444 | 1669 | 1870 | 2072 | 2535 | 2997 |
| | 54" | 773 | 877 | 986 | 1095 | 1205 | 1315 | 1429 | 1550 | 1771 | 1982 | 2217 | 2774 | 3333 |
| | 60" | 809 | 928 | 1039 | 1153 | 1270 | 1397 | 1518 | 1646 | 1864 | 2108 | 2362 | 2966 | 3568 |
| | 66" | 845 | 971 | 1092 | 1216 | 1344 | 1478 | 1621 | 1752 | 1965 | 2242 | 2512 | 3153 | 3791 |
| | 72" | 878 | 1015 | 1147 | 1276 | 1419 | 1564 | 1710 | 1855 | 2072 | 2367 | 2660 | 3360 | 4057 |
| | 78" | 905 | 1049 | 1188 | 1334 | 1482 | 1637 | 1786 | 1942 | 2169 | 2488 | 2793 | 3527 | 4262 |
| | 84" | 942 | 1092 | 1236 | 1403 | 1557 | 1720 | 1886 | 2049 | 2282 | 2621 | 2943 | 3706 | 4471 |
| | 90" | 983 | 1132 | 1293 | 1465 | 1635 | 1813 | 1976 | 2151 | 2392 | 2746 | 3089 | 3910 | 4729 |
| | 96" | 1018 | 1182 | 1348 | 1529 | 1710 | 1887 | 2065 | 2247 | 2503 | 2875 | 3237 | 4106 | 4975 |
| | 102" | 1168 | 1352 | 1538 | 1740 | 1922 | 2097 | 2342 | 2571 | 2750 | 3130 | 3490 | 4220 | 5232 |
| | 108" | 1231 | 1422 | 1621 | 1830 | 2018 | 2213 | 2462 | 2711 | 2899 | 3287 | 3674 | 4442 | 5505 |
| 114" | 1304 | 1509 | 1719 | 1941 | 2151 | 2351 | 2613 | 2873 | 3074 | 3490 | 3894 | 4714 | 5845 | |
| 120" | 1403 | 1616 | 1844 | 2078 | 2294 | 2512 | 2793 | 3074 | 3288 | 3737 | 4169 | 5044 | 6247 | |

PRICE CHART 2

ROOM DARKENING

| | | ← Width → | | | | | | | | | | | | |
|------------------|------|-----------|------|------|------|------|------|------|------|------|------|------|------|------|
| | | 24" | 30" | 36" | 42" | 48" | 54" | 60" | 66" | 72" | 84" | 96" | 108" | 120" |
| ↑ Height ↓ | 36" | 733 | 822 | 919 | 1004 | 1097 | 1197 | 1281 | 1378 | 1616 | 1813 | 1996 | 2422 | 2856 |
| | 42" | 776 | 872 | 967 | 1075 | 1172 | 1280 | 1378 | 1476 | 1721 | 1931 | 2136 | 2603 | 3072 |
| | 48" | 817 | 920 | 1033 | 1132 | 1248 | 1359 | 1478 | 1590 | 1836 | 2057 | 2280 | 2790 | 3296 |
| | 54" | 850 | 966 | 1084 | 1206 | 1323 | 1444 | 1575 | 1702 | 1945 | 2177 | 2441 | 3052 | 3662 |
| | 60" | 887 | 1019 | 1142 | 1270 | 1397 | 1535 | 1669 | 1814 | 2050 | 2318 | 2596 | 3260 | 3924 |
| | 66" | 927 | 1069 | 1205 | 1338 | 1476 | 1628 | 1781 | 1929 | 2160 | 2464 | 2764 | 3465 | 4169 |
| | 72" | 967 | 1119 | 1261 | 1405 | 1560 | 1721 | 1877 | 2041 | 2280 | 2603 | 2923 | 3691 | 4462 |
| | 78" | 997 | 1154 | 1306 | 1466 | 1628 | 1799 | 1964 | 2138 | 2383 | 2735 | 3067 | 3878 | 4690 |
| | 84" | 1038 | 1205 | 1361 | 1538 | 1714 | 1891 | 2077 | 2249 | 2511 | 2878 | 3236 | 4078 | 4920 |
| | 90" | 1082 | 1248 | 1422 | 1610 | 1796 | 1990 | 2175 | 2364 | 2631 | 3020 | 3399 | 4301 | 5201 |
| | 96" | 1121 | 1303 | 1483 | 1681 | 1877 | 2078 | 2277 | 2471 | 2756 | 3161 | 3560 | 4518 | 5471 |
| | 102" | 1284 | 1490 | 1692 | 1912 | 2116 | 2309 | 2577 | 2829 | 3029 | 3440 | 3838 | 4646 | 5756 |
| | 106" | 1355 | 1564 | 1781 | 2011 | 2222 | 2434 | 2711 | 2978 | 3186 | 3614 | 4039 | 4884 | 6053 |

SHEER SPECIFICATIONS

Light Filtering Fabrics

- The light filtering fabrics feature vanes that add dimension to any room.

| | |
|----------------------|------|
| Minimum Width | 12" |
| Minimum Height | 12" |
| Maximum Width | 114" |
| Maximum Height | 120" |

Room Darkening Fabrics

- The room darkening fabrics feature vanes that provide light control and privacy.

| | |
|----------------------|------|
| Minimum Width | 12" |
| Minimum Height | 12" |
| Maximum Width | 114" |
| Maximum Height | 106" |

SURCHARGES

| | |
|-----------------------|------|
| Cordless Option | \$99 |
|-----------------------|------|

Prices subject to change without notice

2 1/2" VANE PRICE CHARTS 3-4

PRICE CHART 3

LIGHT FILTERING

| | | ← Width → | | | | | | | | | | | | |
|------------------|------|-----------|------|------|------|------|------|------|------|------|------|------|------|------|
| | | 24" | 30" | 36" | 42" | 48" | 54" | 60" | 66" | 72" | 84" | 96" | 108" | 120" |
| ↑ Height ↓ | 36" | 699 | 784 | 876 | 957 | 1049 | 1141 | 1224 | 1316 | 1539 | 1726 | 1906 | 2315 | 2724 |
| | 42" | 737 | 830 | 923 | 1023 | 1120 | 1223 | 1316 | 1412 | 1642 | 1846 | 2039 | 2483 | 2930 |
| | 48" | 779 | 877 | 985 | 1085 | 1192 | 1293 | 1407 | 1516 | 1752 | 1963 | 2175 | 2661 | 3146 |
| | 54" | 810 | 921 | 1036 | 1150 | 1263 | 1377 | 1502 | 1627 | 1858 | 2079 | 2328 | 2912 | 3497 |
| | 60" | 849 | 972 | 1089 | 1209 | 1331 | 1465 | 1592 | 1727 | 1957 | 2213 | 2480 | 3115 | 3744 |
| | 66" | 886 | 1018 | 1149 | 1278 | 1412 | 1553 | 1701 | 1839 | 2063 | 2353 | 2636 | 3309 | 3981 |
| | 72" | 923 | 1064 | 1203 | 1338 | 1491 | 1642 | 1793 | 1947 | 2175 | 2483 | 2791 | 3526 | 4259 |
| | 78" | 950 | 1100 | 1247 | 1400 | 1554 | 1719 | 1875 | 2040 | 2279 | 2612 | 2930 | 3704 | 4476 |
| | 84" | 988 | 1149 | 1297 | 1471 | 1636 | 1803 | 1980 | 2151 | 2397 | 2750 | 3088 | 3892 | 4697 |
| | 90" | 1031 | 1192 | 1359 | 1537 | 1715 | 1903 | 2075 | 2258 | 2511 | 2882 | 3244 | 4105 | 4964 |
| | 96" | 1069 | 1240 | 1417 | 1605 | 1793 | 1982 | 2167 | 2360 | 2628 | 3017 | 3398 | 4311 | 5222 |
| | 102" | 1225 | 1418 | 1614 | 1825 | 2017 | 2202 | 2460 | 2699 | 2886 | 3286 | 3661 | 4431 | 5496 |
| | 108" | 1290 | 1493 | 1701 | 1921 | 2119 | 2323 | 2585 | 2845 | 3041 | 3451 | 3857 | 4663 | 5781 |
| 114" | 1370 | 1583 | 1802 | 2039 | 2258 | 2468 | 2743 | 3016 | 3227 | 3661 | 4088 | 4948 | 6141 | |
| 120" | 1471 | 1696 | 1936 | 2182 | 2408 | 2636 | 2931 | 3227 | 3452 | 3924 | 4378 | 5296 | 6564 | |

PRICE CHART 4

ROOM DARKENING

| | | ← Width → | | | | | | | | | | | | |
|------------------|------|-----------|------|------|------|------|------|------|------|------|------|------|------|------|
| | | 24" | 30" | 36" | 42" | 48" | 54" | 60" | 66" | 72" | 84" | 96" | 108" | 120" |
| ↑ Height ↓ | 36" | 769 | 865 | 966 | 1054 | 1152 | 1257 | 1344 | 1449 | 1697 | 1905 | 2095 | 2546 | 2998 |
| | 42" | 816 | 915 | 1016 | 1129 | 1234 | 1342 | 1449 | 1553 | 1808 | 2031 | 2242 | 2735 | 3223 |
| | 48" | 857 | 967 | 1086 | 1193 | 1309 | 1426 | 1546 | 1669 | 1928 | 2160 | 2396 | 2930 | 3461 |
| | 54" | 891 | 1015 | 1139 | 1267 | 1389 | 1517 | 1655 | 1788 | 2043 | 2288 | 2563 | 3206 | 3847 |
| | 60" | 932 | 1071 | 1199 | 1334 | 1466 | 1612 | 1753 | 1906 | 2154 | 2436 | 2727 | 3425 | 4120 |
| | 66" | 972 | 1121 | 1264 | 1406 | 1553 | 1711 | 1872 | 2026 | 2266 | 2588 | 2902 | 3638 | 4380 |
| | 72" | 1016 | 1174 | 1325 | 1473 | 1638 | 1808 | 1972 | 2143 | 2396 | 2735 | 3072 | 3876 | 4686 |
| | 78" | 1048 | 1213 | 1371 | 1539 | 1711 | 1889 | 2063 | 2244 | 2502 | 2871 | 3221 | 4074 | 4925 |
| | 84" | 1089 | 1264 | 1427 | 1616 | 1802 | 1987 | 2182 | 2362 | 2636 | 3021 | 3398 | 4283 | 5168 |
| | 90" | 1135 | 1309 | 1494 | 1691 | 1886 | 2092 | 2284 | 2483 | 2764 | 3171 | 3571 | 4518 | 5461 |
| | 96" | 1176 | 1370 | 1556 | 1765 | 1972 | 2183 | 2391 | 2596 | 2896 | 3319 | 3738 | 4746 | 5745 |
| | 102" | 1347 | 1564 | 1778 | 2009 | 2225 | 2427 | 2705 | 2969 | 3177 | 3612 | 4030 | 4879 | 6044 |
| | 106" | 1422 | 1642 | 1872 | 2114 | 2334 | 2555 | 2847 | 3128 | 3343 | 3795 | 4242 | 5129 | 6358 |

SHEER SPECIFICATIONS

Light Filtering Fabrics

- The light filtering fabrics feature vanes that add dimension to any room.

| | |
|----------------------|------|
| Minimum Width | 12" |
| Minimum Height | 12" |
| Maximum Width | 114" |
| Maximum Height | 120" |

Room Darkening Fabrics

- The room darkening fabrics feature vanes that provide light control and privacy.

| | |
|----------------------|------|
| Minimum Width | 12" |
| Minimum Height | 12" |
| Maximum Width | 114" |
| Maximum Height | 106" |

SURCHARGES

| | |
|-----------------------|------|
| Cordless Option | \$99 |
|-----------------------|------|

Prices subject to change without notice

3" VANE PRICE CHARTS 5-6

PRICE CHART 5

LIGHT FILTERING

| | | ← Width → | | | | | | | | | | | | |
|------------|------|-----------|------|------|------|------|------|------|------|------|------|------|------|------|
| | | 24" | 30" | 36" | 42" | 48" | 54" | 60" | 66" | 72" | 84" | 96" | 108" | 120" |
| ↑ Height ↓ | 36" | 733 | 822 | 919 | 1004 | 1097 | 1197 | 1281 | 1378 | 1616 | 1813 | 1996 | 2422 | 2856 |
| | 42" | 776 | 872 | 967 | 1075 | 1172 | 1280 | 1378 | 1476 | 1721 | 1931 | 2136 | 2603 | 3072 |
| | 48" | 817 | 920 | 1033 | 1132 | 1248 | 1359 | 1472 | 1590 | 1836 | 2057 | 2280 | 2790 | 3296 |
| | 54" | 850 | 966 | 1084 | 1206 | 1323 | 1444 | 1575 | 1702 | 1945 | 2177 | 2441 | 3052 | 3662 |
| | 60" | 887 | 1019 | 1142 | 1270 | 1397 | 1535 | 1669 | 1814 | 2050 | 2318 | 2596 | 3260 | 3924 |
| | 66" | 927 | 1069 | 1205 | 1338 | 1476 | 1628 | 1781 | 1929 | 2160 | 2464 | 2764 | 3465 | 4169 |
| | 72" | 967 | 1119 | 1261 | 1405 | 1560 | 1721 | 1877 | 2041 | 2280 | 2603 | 2923 | 3691 | 4462 |
| | 78" | 997 | 1154 | 1306 | 1466 | 1628 | 1799 | 1964 | 2138 | 2383 | 2735 | 3067 | 3878 | 4690 |
| | 84" | 1038 | 1205 | 1361 | 1538 | 1714 | 1891 | 2077 | 2249 | 2511 | 2878 | 3236 | 4078 | 4920 |
| | 90" | 1082 | 1248 | 1422 | 1610 | 1796 | 1990 | 2175 | 2364 | 2631 | 3020 | 3399 | 4301 | 5201 |
| | 96" | 1121 | 1303 | 1483 | 1681 | 1877 | 2078 | 2277 | 2471 | 2756 | 3161 | 3560 | 4518 | 5471 |
| | 102" | 1284 | 1490 | 1692 | 1912 | 2116 | 2309 | 2577 | 2829 | 3029 | 3440 | 3838 | 4646 | 5756 |
| | 108" | 1355 | 1564 | 1781 | 2011 | 2222 | 2434 | 2711 | 2978 | 3186 | 3614 | 4039 | 4884 | 6056 |
| 114" | 1435 | 1660 | 1887 | 2136 | 2364 | 2584 | 2873 | 3159 | 3380 | 3838 | 4283 | 5185 | 6432 | |
| 120" | 1538 | 1778 | 2024 | 2285 | 2528 | 2764 | 3073 | 3380 | 3615 | 4112 | 4587 | 5547 | 6874 | |

PRICE CHART 6

ROOM DARKENING

| | | ← Width → | | | | | | | | | | | | |
|------------|------|-----------|------|------|------|------|------|------|------|------|------|------|------|------|
| | | 24" | 30" | 36" | 42" | 48" | 54" | 60" | 66" | 72" | 84" | 96" | 108" | 120" |
| ↑ Height ↓ | 36" | 806 | 905 | 1011 | 1106 | 1206 | 1317 | 1408 | 1516 | 1777 | 1995 | 2196 | 2666 | 3140 |
| | 42" | 852 | 959 | 1065 | 1182 | 1289 | 1406 | 1516 | 1624 | 1894 | 2128 | 2349 | 2864 | 3379 |
| | 48" | 899 | 1012 | 1136 | 1249 | 1371 | 1493 | 1620 | 1748 | 2017 | 2263 | 2507 | 3071 | 3626 |
| | 54" | 934 | 1064 | 1193 | 1325 | 1454 | 1588 | 1732 | 1872 | 2140 | 2397 | 2682 | 3357 | 4031 |
| | 60" | 977 | 1121 | 1256 | 1399 | 1535 | 1689 | 1837 | 1996 | 2258 | 2549 | 2856 | 3589 | 4317 |
| | 66" | 1019 | 1172 | 1325 | 1472 | 1624 | 1792 | 1958 | 2123 | 2375 | 2712 | 3040 | 3811 | 4587 |
| | 72" | 1065 | 1231 | 1388 | 1545 | 1718 | 1894 | 2065 | 2243 | 2507 | 2864 | 3216 | 4061 | 4909 |
| | 78" | 1097 | 1270 | 1438 | 1613 | 1793 | 1979 | 2160 | 2351 | 2622 | 3007 | 3373 | 4267 | 5157 |
| | 84" | 1141 | 1325 | 1496 | 1692 | 1886 | 2083 | 2285 | 2475 | 2760 | 3166 | 3558 | 4486 | 5411 |
| | 90" | 1190 | 1371 | 1564 | 1771 | 1976 | 2189 | 2392 | 2600 | 2896 | 3321 | 3739 | 4733 | 5722 |
| | 96" | 1235 | 1434 | 1630 | 1847 | 2065 | 2286 | 2503 | 2719 | 3032 | 3478 | 3915 | 4969 | 6020 |
| | 102" | 1411 | 1637 | 1863 | 2101 | 2329 | 2539 | 2833 | 3112 | 3331 | 3783 | 4222 | 5110 | 6331 |
| | 106" | 1490 | 1720 | 1958 | 2214 | 2445 | 2676 | 2984 | 3277 | 3504 | 3975 | 4442 | 5373 | 6661 |

SHEER SPECIFICATIONS

Light Filtering Fabrics

- The light filtering fabrics feature vanes that add dimension to any room.

| | |
|----------------------|------|
| Minimum Width | 12" |
| Minimum Height | 12" |
| Maximum Width | 114" |
| Maximum Height | 120" |

Room Darkening Fabrics

- The room darkening fabrics feature vanes that provide light control and privacy.

| | |
|----------------------|------|
| Minimum Width | 12" |
| Minimum Height | 12" |
| Maximum Width | 114" |
| Maximum Height | 106" |

SURCHARGES

Cordless Option\$99

Prices subject to change without notice

WARRANTY

CHILD SAFETY

Every product we send out meets or exceeds the latest safety standards as set forth by the Consumer Product Safety Council and the Window Covering Manufacturers Association. For enhanced safety, Automated Motorized Shades offers cordless and motorized window treatments.

REMEMBER THESE SAFETY RULES...

- For children's bedrooms only install window coverings that are cordless.
- Any window coverings in your home that were made before 2001, should be replaced with today's newer, safer models.
- Do not place furniture near windows that have window coverings with cords.
- Keep all cords out of reach from small children. Do this by securing tasseled pull cords out of reach with a cord cleat, and anchoring continuous-loop cords to the wall with safety devices.
- Always be sure to lock and firmly secure cords in position.
- Products such as Roman or Woven Wood Shades that have accessible back cords, should not be installed within reach of children.

All products come with safety labels attached. This is to help raise awareness of the potential safety risks associated with the products you purchase. If you have any concerns, please do not hesitate to contact us directly. You may also directly contact any of the associations that create the safety standards with any questions or concerns. Child safety is our top priority!

WARRANTY

Automated Motorized Shades guarantees all products manufactured in our facility to be free from defects due to faulty workmanship and/or materials. We are so confident about our quality and dependability that we back our manual shades with a limited lifetime warranty, our motors with a 5 year limited warranty, and our custom printed shades with a 3 year warranty against fading. All warranties are effective from the original invoice date of the product.

This guarantee does not apply to damage to exterior shades caused by high winds and/or extreme weather conditions. Any roller shade or parts which fail due to abuse, accident, theft, alterations, improper use or

installation, or gradual color fading, are also excluded from this warranty.

Automated Motorized Shades reserves the right to inspect products and will replace or repair any product found to be defective as a result of faulty workmanship or materials.

Shipping charges, trip charges and labor costs for measuring and installation and/or removal of old or current products are excluded. This

warranty is available to the original owner/purchaser and is non-transferable. Automated Motorized Shades' warranty is designed to ensure a thoroughly satisfying experience with your window treatment product. Certain restrictions may apply.

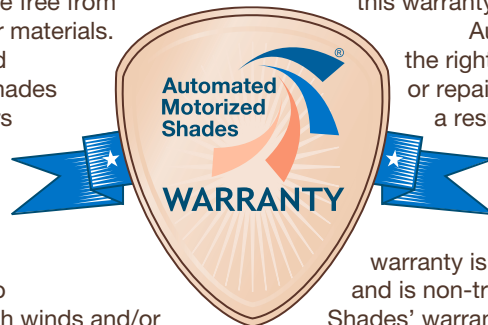



HONEYCOMB COLLECTION

PRICING GUIDE

TABLE OF CONTENTS

| | |
|--|-------|
| Features & Benefits | 1 |
| Measuring Instructions | 2 |
| Design Options | 3 |
| Fabric Choices | 4 |
| Fabric Selection..... | 5-6 |
| Shade Size Specifications | 7-9 |
| Arch & Quarter Size Specifications | 10 |
| Product Specifications | 11-12 |
| Standard Rectangular Price Charts..... | 13-20 |
| Price Chart 1 | 13 |
| Price Chart 2 | 14 |
| Price Chart 3 | 15 |
| Price Chart 4 | 16 |
| Price Chart 5 | 17 |
| Price Chart 6 | 18 |
| Price Chart 7 | 19 |
| Price Chart 8 | 20 |
| Longitude Specifications | 21-22 |
| Longitude Price Charts..... | 23-24 |
| Longitude Price Chart 1-2 | 23 |
| Longitude Price Chart 3-4 | 24 |
| Child Safety & Warranty | 25 |

FEATURES & BENEFITS

- Honeycomb construction provides superior insulation and energy efficiency
- Fabric available in wide widths to cover larger windows without seams or overlap
- Neutral white backing provides a uniform appearance to the outside of the home
- 100% crisp polyester fabric repels dust and dirt, and is easy to clean and maintain
- Multiple design options and operating systems are available
- Longitude honeycomb shades move vertically, offering an option that works well for sliding doors

MEASURING INSTRUCTIONS

MEASUREMENTS

Accurate measurements are essential, for both correct pricing and proper fit. Use only a hard-edged ruler or steel tape, never a cloth tape. For inside mounts, width measurements (A) should be rounded down to the nearest 1/8" to prevent blind from rubbing against the window casing.

INSIDE MOUNT

Use a steel tape to measure the opening width (A) at three different places, and use the narrowest dimension when ordering. Be exact! The factory will make the shade 3/8" narrower so it will not rub against the window casing. Measure the height (B) of the window from the top (Soffit) down to the sill.

OUTSIDE MOUNT

Use a steel tape to measure the exact width (A) and height (B) of the area to be covered. It is recommended that the shades overlap the window by at least 1-1/2" on each side. When installation has no sill, allow the shade to overlap the bottom of the window casing by at least 1-1/2". Shade fabric will measure the width and height indicated on the order form.

ARCHES & QUARTER CIRCLES

- For inside mounts, measure the exact width and height inside the window opening.
- For outside mounts, measure the desired width and height.
- Measure the height at its tallest point.
- All arch openings can only be for perfect arches where the height will equal 1/2 the width.
- For all quarter circles, the height must equal the width.

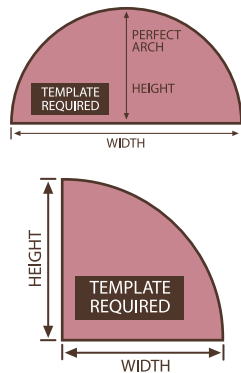

CUT-OUTS

- Cut-outs are available with all fabrics.
- Cut-outs are \$89 per side and are subject to approval by the fabricator.
- There are no limits on cut-out heights. There are, however, limits on cut-out widths:
 - Shade width less than 18": 3" Max. Width
 - Shade width greater than 18": 5" Max. Width

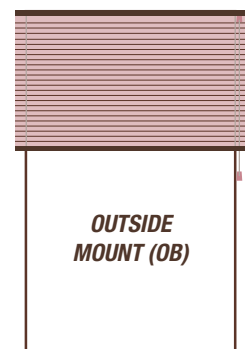
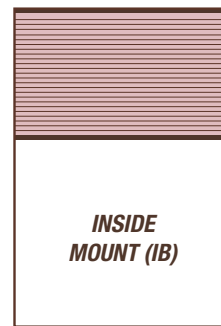
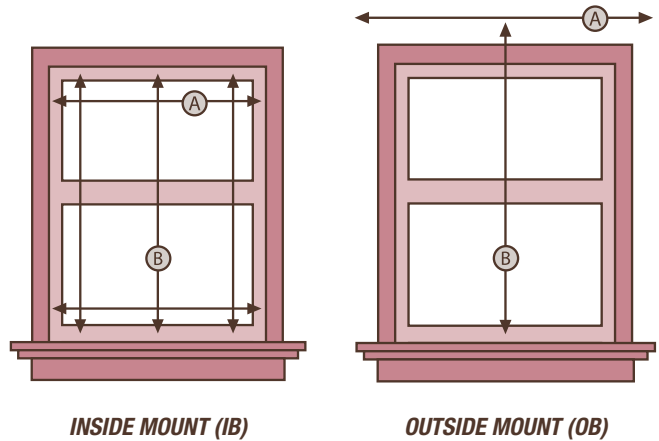

5 STEPS TO AN ACCURATE TEMPLATE

1. Tape butcher paper or heavy wrapping paper over the window opening allowing plenty of overlap. Do not use paper that has ever been folded; a template can have no folds or creases.
2. Draw an exact outline of the window opening. Do this by carefully tracing over the inside edge of the window frame.
3. Remove the paper from the window opening. If the blind is an outside mount, add the desired amount of overlap to the window outline and draw a second outline around it to match the shape of the finished blind.
4. Mark the blind dimensions on the template. Check that the template dimensions match the measurements of the actual window opening.
5. Identify the template and its orientation. Write the customer's name and PO# on the template, and mark the "Room Side" and "Top". Roll up the template and place it in a

Note: Do not fold the template. Template must be cut out in the exact shape of the window opening and tested in window for correct fit.

For any arches requiring a template, there will be a template surcharge of \$151 added to the price of the arch.

Prices subject to change without notice

DESIGN OPTIONS

HONEYCOMB SHADES

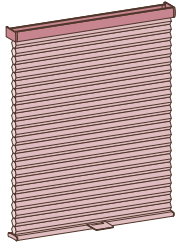

CORDLESS

This system eliminates exposed cords and is easy to adjust by lifting or lowering the shade with a gentle push or pull on the bottom-rail. Eliminates danger of dangling cords to children and pets. Also available in top-down/bottom-up. Now available with the Lift & Lock system that makes raising your shade as simple as pushing a button.

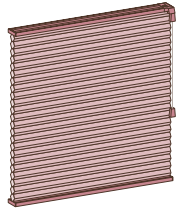

STANDARD RECTANGULAR

Traditional cord operated honeycomb shade that raises from the bottom up and stacks at the top.

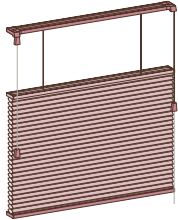

TOP-DOWN/BOTTOM-UP

This shade can be opened from both the top and the bottom. Right and left hand controls move the middle and bottom rails to raise and lower the shade. This style is ideal for letting natural light in through the top while preserving privacy below.

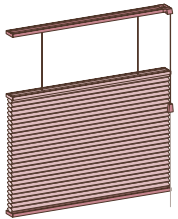

TOP-DOWN ONLY

Privacy is maintained while allowing natural light in, this shade stacks neatly at the bottom of the window when fully open. This top-down feature provides a unique look to a window.

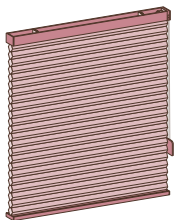

CONTINUOUS CORD LOOP

A continuous cord loop opens and closes the shade smoothly and evenly eliminating the traditional dangling cord. It also offers a neater, cleaner appearance. A special clutch system keeps the shade at the desired height and is an ideal option for



MOTORIZED

Suitable for all applications, including hard to reach windows. Available in 12 volt battery, 24 volt plug in, & 120 volt plug-in configurations. Motors allow you to control any size shade at the touch of a button. All of our motorization options eliminate dangling cords and the associated hazards for children and pets. Please consult our Motorization guide.

HONEYCOMB SHADES CONT...

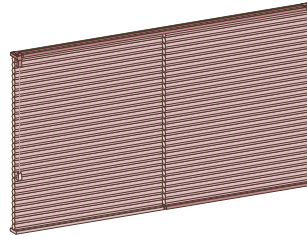

2-ON-1 HEADRAIL

For very large single windows or two large windows side by side, this specialty shade provides the appearance of a single shade, with two sections operating independently.

DAY-NIGHT SHADE

This style of shade utilizes two different fabrics on one shade. A translucent fabric is used on the top and a blackout fabric on the bottom connected by a moving rail. This shade provides a variety of light control and privacy options.

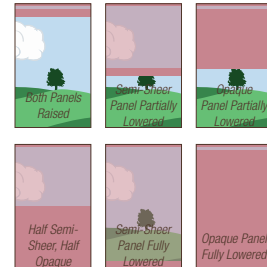

ARCHES

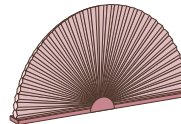

STATIONARY ARCH

This classic star-burst design has no moving rail.

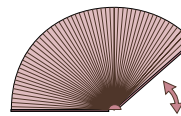

MOVABLE ARCH

This star-burst design fits perfect arch openings and is fully operable.

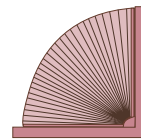

STATIONARY QUARTER CIRCLE

The shade has no moving rail and remains permanently closed.

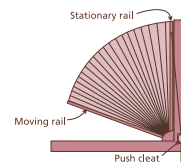

MOVABLE QUARTER CIRCLE

This specialty shade has a moving rail for light control and fits quarter circle windows where the height equals the width.

Please refer to price grids for surcharge information

FABRIC CHOICES

PRIVACY & LIGHT CONTROL OPTIONS

Honeycomb shades are available in 4 opacities: sheer, semi-sheer, translucent, and blackout. Each offers a different degree of privacy and light control.

SHEER & SEMI-SHEER FABRICS

- Transmits light with view through the shade
- Does not provide privacy
- Available in ¾" Single Cell Fabrics



TRANSLUCENT FABRICS

- Transmits filtered light with no view through the shade
- Provides moderate privacy
- Available in ¾", 3/8", and 9/16" - Single Cell and Double Cell fabrics



BLACKOUT FABRICS

- Blocks 99% of outside light
- Provides complete privacy and light control
- Available in ¾", 3/8", and 9/16" - Single Cell and Double Cell fabrics



ELEGANCE COLLECTION

The Elegance Collection features beautiful, high-quality fabrics that add warmth and a designer style to your home's decor.

- ¾" Woven fabric is available in translucent or blackout and offers deep, vibrant and consistent colors
- The ¾" Ultra Soft collection's offers rich in a luxuriously soft fabric for your windows
- Exclusively in the Elegance Collection, the ¾" Sheer or Semi-Sheer Knitted fabrics have a fresh look and open view to the outside

CLASSIC COLLECTION

The Soft Touch Collection offers a budget friendly collection with all of the standard options available.

- 3/8" Soft Touch is available in translucent and blackout fabrics
- 9/16" Soft Touch is available in translucent and blackout fabrics
- The unique and distinctive 9/16" Pointbond is available in translucent colors
- Double Cell Soft Touch fabrics are available in translucent and blackout styles

SOFT TOUCH COLLECTION

With the largest selection of fabrics and styles, our Classic Collection offers it all. Time-honored favorites and trendy new fabrics are available in a wide variety of colors, sizes, solids and textures.

- Classic fabrics come in translucent or blackout styles
- 3/8" Textured is available in translucent opacity only
- ¾" Flame Retardant fabrics are available in translucent and blackout
- Double Cell Texture and Classic colors are available in translucent fabrics

ENERGY EFFICIENCY

Honeycomb shades are among the most energy-efficient window coverings available. The insular property of honeycomb fabric is attributed to its unique cellular construction creating a barrier of chambers designed to reduce heat and the damaging effects of UV light. Our premium honeycomb fabrics are separated into three simple levels of energy efficiency (Good, Better, Best) to help you maximize your budget and enhance comfort in your home.

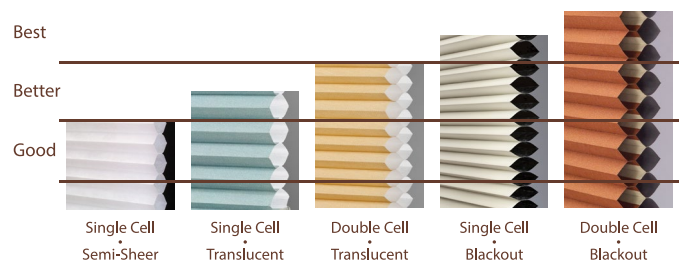

FABRIC SELECTION

| Name | Honeycomb Price Chart | Longitude Price Chart |
|--|-----------------------|-----------------------|
| D-06 • 3/4" Single Cell Semi Sheer | 7 | N/A |
| D-07 • 3/4" Single Cell Blackout | 4 | L1 |
| D-08/D-09 • 3/4" Single Cell Sheer | 7 | N/A |
| D-13/D-14/D-15 • 3/4" Single Cell Translucent | 6 | L2 |
| D-16 • 3/4" Single Cell Flame Retardant Blackout | 7 | L3 |
| D-19 • 3/4" Single Cell Semi-Sheer | 8 | N/A |
| D-20 • 3/4" Single Cell Flame Retardant Translucent | 6 | L2 |
| F-08 • 3/8" Single Cell Translucent | 4 | N/A |
| F-09 • 3/8" Single Cell Blackout | 7 | N/A |
| F-15 • 1/2" Double Cell Translucent | 4 | N/A |
| F-16 • 3/4" Single Cell Linen Translucent Essentials * | 4 | L1 |
| F-17 • 3/4" Single Cell Blackout Essentials * | 7 | L3 |
| F-25 • 1/2" Double Cell Textured Translucent | 5 | N/A |
| F-26 • 3/4" Single Cell Textured Translucent | 3 | L1 |
| F-27 • 3/4" Single Cell Textured Blackout | 6 | L2 |
| F-28 • 3/8" Single Cell Textured Translucent | 3 | N/A |
| F-29 • 3/8" Single Cell Textured Blackout | 8 | N/A |
| F-36 • 3/4" Single Cell Brushed Translucent | 6 | L2 |
| F-37 • 3/4" Single Cell Brushed Blackout | 7 | L3 |
| F-50 • 3/4" Single Cell Translucent | 4 | L1 |
| F-56 • 3/4" Single Cell Translucent | 5 | L1 |
| G-23/G-24/G-25 • 3/4" Single Cell Blackout | 7 | L3 |
| T-04 • 1/2" Double Cell Translucent Essentials | 3 | N/A |
| T-05 • 3/4" Single Cell Translucent Essentials | 2 | N/A |
| T-08 • 3/4" Single Cell Blackout Essentials | 5 | N/A |
| T-21 • 3/4" Single Cell Bi-Lam Blackout Essentials | 3 | N/A |
| T-23 • 1/2" Double Cell Blackout Essentials | 6 | N/A |
| T-32 • Grand Pleat Translucent | 6 | L2 |
| T-37 • Grand Pleat Blackout | 7 | F3 |
| T-41 • 3/4" Single Cell Translucent | 1 | N/A |
| T-43 • 1/2" Double Cell Translucent | 2 | N/A |
| T-91 • Bar Harbor | 8 | N/A |

FABRIC SELECTION

VERTICAL HONEYCOMB OPTIONS

| Name | Honeycomb Price Chart | Maximum Size One Way Draw | Maximum Size Center Opening |
|--|-----------------------|---------------------------|-----------------------------|
| D-06 • 3/4" Single Cell Semi Sheer | L3 | 168" x 120" | 192" x 120" |
| D-07 • 3/4" Single Cell Blackout | L1 | 168" x 120" | 192" x 120" |
| D-08 • 3/4" Single Cell Sheer | L3 | 120" x 120" | 192" x 120" |
| D-09 • 3/4" Single Cell Sheer | L3 | 120" x 120" | 192" x 120" |
| D-13 • 3/4" Single Cell Translucent | L2 | 168" x 120" | 192" x 120" |
| D-14 • 3/4" Single Cell Translucent | L2 | 168" x 120" | 192" x 120" |
| D-15 • 3/4" Single Cell Translucent | L2 | 168" x 120" | 192" x 120" |
| F-16 • 3/4" Single Cell Linen Translucent | L1 | 168" x 120" | 192" x 120" |
| F-17 • 3/4" Single Cell Blackout | L2 | 168" x 120" | 192" x 120" |
| F-26 • 3/4" Single Cell Textured Translucent | L1 | 168" x 120" | 192" x 120" |
| F-27 • 3/4" Single Cell Textured Blackout | L2 | 168" x 120" | 192" x 120" |
| F-36 • 3/4" Single Cell Translucent | L2 | 168" x 120" | 192" x 120" |
| F-37 • 3/4" Single Cell Blackout | L3 | 168" x 120" | 192" x 120" |
| F-56 • 3/4" Single Cell Translucent | L1 | 168" x 120" | 192" x 120" |
| G-03 • 3/4" Single Cell Woven Translucent | L4 | 168" x 120" | 192" x 120" |
| G-04 • 3/4" Single Cell Woven Blackout | L4 | 168" x 120" | 192" x 120" |
| G-23 • 3/4" Single Cell Blackout | L3 | 168" x 120" | 192" x 120" |
| G-24 • 3/4" Single Cell Blackout | L3 | 168" x 120" | 192" x 120" |
| G-25 • 3/4" Single Cell Blackout | L3 | 168" x 120" | 192" x 120" |
| T-21 • 3/4" Single Cell Blackout | L1 | 168" x 120" | 192" x 120" |
| T-21L • 3/4" Single Cell Blackout Linen | L1 | 168" x 120" | 192" x 120" |

SHADE SIZE SPECIFICATIONS

| Fabric Type | Std. | TD | TDBU | Day/ Night* | 2-on-1 | Lift & Lock Cordless | Std Cordless | Cordless TDBU | Std Cont. Cord | Continuous Cord TDBU | 2-on-1 Cont. Cord | Longitude** |
|---|--------------|------|------|----------------|--------------|----------------------------|-----------------|------------------|----------------------|-------------------------|-------------------------|-------------|
| Minimum Sizes | Width: 12" | 12" | 12" | 12" | 44" | 18" | 18" | 18" | 22" | 24" | 44" | 12" |
| | Height: 8" | 12" | 12" | 18" | 8" | 8" | 8" | 8" | 8" | 8" | 8" | 24" |
| D-06 • 3/4" Single Cell Semi Sheer | Width: 174" | 108" | 72" | 72" | 144" | 120" | 120" | 120" | 144" | 144" | 144" | NA |
| | Height: 120" | 120" | 108" | 96" | 120" | 84" | 84" | 84" | 120" | 120" | 120" | NA |
| | Sq Ft: 60 | 60 | 30 | 30/Shade | 60/ Shade | 70 | 70 | 70 | 120 | 120 | 60/ Shade | NA |
| D-07 • 3/4" Single Cell Blackout | Width: 174" | 108" | 72" | 72" | 144" | 120" | 120" | 120" | 144" | 144" | 144" | 168" |
| | Height: 120" | 120" | 108" | 96" | 120" | 84" | 84" | 84" | 120" | 120" | 120" | 120" |
| | Sq Ft: 60 | 60 | 30 | 30/Shade | 60/ Shade | 70 | 70 | 70 | 120 | 120 | 60/ Shade | 140 |
| D-08/D-09 • 3/4" Single Cell Sheer | Width: 174" | 108" | 72" | 72" | 144" | 120" | 120" | 120" | 144" | 144" | 144" | 120" |
| | Height: 120" | 120" | 108" | 96" | 120" | 84" | 84" | 84" | 120" | 120" | 120" | 120" |
| | Sq Ft: 60 | 60 | 48 | 30/Shade | 60/ Shade | 70 | 70 | 70 | 120 | 120 | 60/ Shade | 140 |
| D-13/D-14/D-15 • 3/4" Single Cell Translucent | Width: 174" | 108" | 72" | 72" | 144" | 120" | 120" | 120" | 144" | 144" | 144" | 168" |
| | Height: 120" | 120" | 108" | 96" | 120" | 84" | 84" | 84" | 120" | 120" | 120" | 120" |
| | Sq Ft: 60 | 60 | 30 | 30/Shade | 60/ Shade | 70 | 70 | 70 | 120 | 120 | 60/ Shade | 140 |
| D-16 • 3/4" Single Cell Flame Retardant Blackout | Width: 174" | 108" | 72" | 72" | 144" | 120" | 120" | NA | 144" | 144" | 144" | NA |
| | Height: 120" | 120" | 108" | 96" | 120" | 84" | 84" | NA | 120" | 120" | 120" | NA |
| | Sq Ft: 40 | 40 | 40 | 30/Shade | 60/ Shade | 70 | 70 | NA | 120 | 120 | 60/ Shade | NA |
| D-19 • 3/4" Single Cell Semi-Sheer | Width: 174" | 108" | 72" | 72" | 144" | 120" | 120" | 120" | 144" | 144" | 144" | NA |
| | Height: 120" | 120" | 108" | 96" | 120" | 84" | 84" | 84" | 120" | 120" | 120" | NA |
| | Sq Ft: 60 | 60 | 30 | 30/Shade | 60/ Shade | 70 | 70 | 70 | 120 | 120 | 60/ Shade | NA |
| D-20 • 3/4" Single Cell Flame Retardant Translucent | Width: 174" | 108" | 72" | 72" | 144" | 120" | 120" | NA | 144" | 144" | 144" | 168" |
| | Height: 120" | 138" | 108" | 96" | 120" | 84" | 84" | NA | 120" | 120" | 120" | 120" |
| | Sq Ft: 60 | 60 | 30 | 30/Shade | 60/ Shade | 70 | 70 | NA | 120 | 120 | 60/ Shade | 140 |
| F-08 • 3/8" Single Cell Translucent | Width: 174" | 108" | 72" | 72" | 144" | 120" | 120" | 120" | 144" | 144" | 144" | NA |
| | Height: 120" | 120" | 108" | 96" | 120" | 84" | 84" | 84" | 120" | 120" | 120" | NA |
| | Sq Ft: 60 | 60 | 48 | 48/Shade | 60/ Shade | 70 | 70 | 70 | 120 | 120 | 60/ Shade | NA |
| F-09 • 3/8" Single Cell Blackout | Width: 174" | 108" | 72" | 72" | 144" | 120" | NA | NA | 144" | 144" | 144" | NA |
| | Height: 120" | 120" | 108" | 96" | 120" | 84" | NA | NA | 120" | 120" | 120" | NA |
| | Sq Ft: 60 | 40 | 40 | 48/Shade | 60/ Shade | 70 | NA | NA | 120 | 120 | 60/ Shade | NA |
| F-15 • 1/2" Double Cell Translucent | Width: 174" | 108" | 72" | 60" | 144" | 120" | 120" | 120" | 144" | 144" | 144" | NA |
| | Height: 120" | 120" | 108" | 96" | 120" | 84" | 84" | 84" | 120" | 120" | 120" | NA |
| | Sq Ft: 40 | 40 | 40 | 30/Shade | 60/ Shade | 70 | 70 | 70 | 120 | 120 | 60/ Shade | NA |
| F-16 • 3/4" Single Cell Linen Translucent Essentials * | Width: 174" | 108" | 72" | 72" | 144" | 120" | 120" | 120" | 144" | 144" | 144" | 168" |
| | Height: 120" | 120" | 108" | 96" | 120" | 84" | 4" | 84" | 120" | 120" | 120" | 120" |
| | Sq Ft: 60 | 60 | 40 | 48/Shade | 60/ Shade | 70 | 70 | 70 | 120 | 120 | 60/ Shade | 140 |

*Day-Night Note: Fabrics marked with an asterisk are available as only the bottom panel in a Day-Night shade.

**Longitude Note: For center opening or dual panel Longitude shades, specifications are per fabric panel. Center opening shades are available in widths up to 336". If width is greater than 185", it will be need fabricated as two shades.

SHADE SIZE SPECIFICATIONS

| Fabric Type | Std. | TD | TDBU | Day/ Night* | 2-on-1 | Lift & Lock Cordless | Std Cordless | Cordless TDBU | Std Cont. Cord | Continuous Cord TDBU | 2-on-1 Cont. Cord | Longitude** |
|--|--------------|------|------|----------------|--------------|----------------------------|-----------------|------------------|----------------------|-------------------------|-------------------------|-------------|
| Minimum Sizes | Width: 12" | 12" | 12" | 12" | 44" | 18" | 18" | 18" | 22" | 24" | 44" | 12" |
| | Height: 8" | 12" | 12" | 18" | 8" | 8" | 8" | 8" | 8" | 8" | 8" | 24" |
| F-17 • 3/4" Single Cell Blackout Essentials * | Width: 174" | 108" | 72" | 72" | 144" | 120" | 120" | 120" | 144" | 144" | 144" | 168" |
| | Height: 120" | 120" | 108" | 96" | 120" | 84" | 84" | 84" | 120" | 120" | 120" | 120" |
| | Sq Ft: 40 | 40 | 40 | 40/Shade | 40/ Shade | 70 | 70 | 70 | 120 | 120 | 60/ Shade | 140 |
| F-25 • 1/2" Double Cell Textured Translucent | Width: 174" | 108" | 72" | 60" | 144" | 120" | 120" | 120" | 144" | 144" | 144" | NA |
| | Height: 120" | 120" | 8" | 96" | 120" | 84" | 84" | 84" | 120" | 120" | 120" | NA |
| | Sq Ft: 40 | 40 | 40 | 30/Shade | 60/ Shade | 70 | 70 | 70 | 120 | 120 | 60/ Shade | NA |
| F-26 • 3/4" Single Cell Textured Translucent | Width: 174" | 108" | 72" | 72" | 144" | 120" | 120" | 120" | 144" | 144" | 144" | 168" |
| | Height: 120" | 120" | 108" | 96" | 120" | 84" | 84" | 84" | 120" | 120" | 120" | 120" |
| | Sq Ft: 60 | 60 | 40 | 48/Shade | 60/ Shade | 70 | 70 | 70 | 120 | 120 | 60/ Shade | 140 |
| F-27 • 3/4" Single Cell Textured Blackout | Width: 174" | 108" | 72" | 72" | 144" | 120" | 120" | 120" | 144" | 144" | 144" | 168" |
| | Height: 120" | 120" | 108" | 96" | 120" | 84" | 84" | 84" | 120" | 120" | 120" | 120" |
| | Sq Ft: 40 | 40 | 40 | 40/Shade | 40/ Shade | 70 | 70 | 70 | 120 | 120 | 60/ Shade | 140 |
| F-28 • 3/8" Single Cell Textured Translucent | Width: 174" | 108" | 72" | 72" | 144" | 120" | 120" | 120" | 144" | 144" | 144" | NA |
| | Height: 120" | 120" | 108" | 96" | 120" | 84" | 84" | 84" | 120" | 120" | 120" | NA |
| | Sq Ft: 60 | 60 | 48 | 48/Shade | 60/ Shade | 70 | 70 | 70 | 120 | 120 | 60/ Shade | NA |
| F-29 • 3/8" Single Cell Textured Blackout | Width: 174" | 108" | 72" | 72" | 144" | 120" | NA | NA | 144" | 144" | 144" | NA |
| | Height: 120" | 120" | 108" | 96" | 120" | 84" | NA | NA | 120" | 120" | 120" | NA |
| | Sq Ft: 60 | 40 | 40 | 48/Shade | 60/ Shade | 70 | NA | NA | 120 | 120 | 60/ Shade | NA |
| F-36 • 3/4" Single Cell Brushed Translucent | Width: 174" | 108" | 72" | 72" | 144" | 120" | 120" | 120" | 144" | 144" | 144" | 168" |
| | Height: 120" | 120" | 108" | 96" | 120" | 84" | 84" | 84" | 120" | 120" | 120" | 120" |
| | Sq Ft: 60 | 60 | 40 | 48/Shade | 60/ Shade | 70 | 70 | 70 | 120 | 120 | 60/ Shade | 140 |
| F-37 • 3/4" Single Cell Brushed Blackout | Width: 174" | 108" | 72" | 72" | 144" | 120" | 120" | 120" | 144" | 144" | 144" | 168" |
| | Height: 120" | 120" | 108" | 96" | 120" | 84" | 84" | 84" | 120" | 120" | 120" | 120" |
| | Sq Ft: 40 | 40 | 40 | 40/Shade | 40/ Shade | 70 | 70 | 70 | 120 | 120 | 60/ Shade | 140 |
| F-50 • 3/4" Single Cell Translucent | Width: 174" | 108" | 72" | 72" | 144" | 120" | 120" | 120" | 144" | 144" | 144" | 168" |
| | Height: 120" | 120" | 108" | 96" | 120" | 84" | 84" | 84" | 120" | 120" | 120" | 120" |
| | Sq Ft: 60 | 60 | 40 | 48/Shade | 60/ Shade | 70 | 70 | 70 | 120 | 120 | 60/ Shade | 140 |
| F-56 • 3/4" Single Cell Translucent | Width: 174" | 108" | 72" | 72" | 144" | 120" | 120" | 120" | 144" | 144" | 144" | 168" |
| | Height: 120" | 120" | 108" | 96" | 120" | 84" | 84" | 84" | 120" | 120" | 120" | 120" |
| | Sq Ft: 60 | 60 | 40 | 48/Shade | 60/ Shade | 70 | 70 | 70 | 120 | 120 | 60/ Shade | 140 |

*Day-Night Note: Fabrics marked with an asterisk are available as only the bottom panel in a Day-Night shade.

**Longitude Note: For center opening or dual panel Longitude shades, specifications are per fabric panel. Center opening shades are available in widths up to 336". If width is greater than 185", it will be need fabricated as two shades.

SHADE SIZE SPECIFICATIONS

| Fabric Type | Std. | TD | TDBU | Day/ Night* | 2-on-1 | Lift & Lock Cordless | Std Cordless | Cordless TDBU | Std Cont. Cord | Continuous Cord TDBU | 2-on-1 Cont. Cord | Longitude** | |
|---|---------|------|------|----------------|----------|----------------------------|-----------------|------------------|----------------------|-------------------------|-------------------------|--------------|------|
| Minimum Sizes | Width: | 12" | 12" | 12" | 12" | 44" | 18" | 18" | 18" | 22" | 24" | 44" | 12" |
| | Height: | 8" | 12" | 12" | 18" | 8" | 8" | 8" | 8" | 8" | 8" | 8" | 24" |
| G-23/G-24/G-25 • 3/4" Single Cell Blackout | Width: | 144" | 108" | 72" | 72" | 144" | 120" | 120" | 120" | 144" | 144" | 144" | 168" |
| | Height: | 120" | 120" | 108" | 96" | 120" | 84" | 84" | 84" | 120" | 120" | 120" | 120" |
| | Sq Ft: | 40 | 40 | 40 | 40/Shade | 40/ Shade | 70 | 70 | 70 | 120 | 120 | 60/ Shade | 140 |
| T-04 • 1/2" Double Cell Translucent Essentials | Width: | 144" | 72" | 72" | 72" | 144" | 120" | 120" | 120" | 144" | 144" | 144" | NA |
| | Height: | 120" | 96" | 96" | 96" | 120" | 84" | 84" | 84" | 120" | 120" | 120" | NA |
| | Sq Ft: | 60 | 48 | 48 | 48/Shade | 60/ Shade | 70 | 70 | 70 | 120 | 120 | 60/ Shade | NA |
| T-05 • 3/4" Single Cell Translucent Essentials | Width: | 144" | 72" | 72" | 72" | 144" | 120" | 120" | 120" | 144" | 144" | 144" | NA |
| | Height: | 120" | 96" | 96" | 96" | 120" | 84" | 84" | 84" | 120" | 120" | 120" | NA |
| | Sq Ft: | 60 | 48 | 48 | 48/Shade | 60/ Shade | 70 | 70 | 70 | 120 | 120 | 60/ Shade | NA |
| T-08 • 3/4" Single Cell Blackout Essentials | Width: | 144" | 72" | 72" | 72" | 144" | 120" | 84" | 84" | 144" | 144" | 144" | NA |
| | Height: | 120" | 96" | 80" | 80" | 120" | 84" | 84" | 84" | 120" | 120" | 120" | NA |
| | Sq Ft: | 60 | 40 | 40 | 40/Shade | 60/ Shade | 70 | 49 | 49 | 120 | 120 | 60/ Shade | NA |
| T-21 • 3/4" Single Cell Bi-Lam Blackout Essentials | Width: | 144" | 108" | 72" | 72" | 144" | 120" | 120" | 120" | 144" | 144" | 144" | 168" |
| | Height: | 120" | 120" | 108" | 96" | 120" | 84" | 84" | 84" | 120" | 120" | 120" | 120" |
| | Sq Ft: | 40 | 40 | 40 | 40/Shade | 40/ Shade | 70 | 70 | 70 | 120 | 120 | 60/ Shade | 140 |
| T-23 • 1/2" Double Cell Blackout Essentials | Width: | 120" | 72" | 72" | 72" | 128" | 120" | 84" | 4" | 128" | 128" | 128" | NA |
| | Height: | 120" | 96" | 96" | 96" | 120" | 84" | 84" | 84" | 120" | 120" | 120" | NA |
| | Sq Ft: | 60 | 40 | 40 | 40/Shade | 53/ Shade | 70 | 49 | 49 | 106 | 106 | 53/ Shade | NA |
| T-32 • Grand Pleat Translucent | Width: | NA | NA | NA | NA | NA | 120" | 120" | 120" | 144" | NA | NA | 168" |
| | Height: | NA | NA | NA | NA | NA | 84" | 84" | 84" | 120" | NA | NA | 120" |
| | Sq Ft: | NA | NA | NA | NA | NA | 70 | 70 | 70 | 120 | NA | NA | 140 |
| T-37 • Grand Pleat Blackout | Width: | NA | NA | NA | NA | NA | 120" | 120" | 120" | 144" | NA | NA | 168" |
| | Height: | NA | NA | NA | NA | NA | 84" | 84" | 84" | 120" | NA | NA | 120" |
| | Sq Ft: | NA | NA | NA | NA | NA | 70 | 70 | 70 | 120 | NA | NA | 140 |
| T-41 • 3/4" Single Cell Translucent | Width: | 144" | 72" | 72" | 72" | 144" | 120" | 120" | 120" | 144" | 144" | 144" | NA |
| | Height: | 120" | 96" | 96" | 96" | 120" | 84" | 84" | 84" | 120" | 120" | 120" | NA |
| | Sq Ft: | 0 | 48 | 48 | 48/Shade | 60/ Shade | 70 | 70 | 70 | 120 | 120 | 60/ Shade | NA |
| T-43 • 1/2" Double Cell Translucent | Width: | 144" | 72" | 72" | 72" | 144" | 120" | 120" | 120" | 144" | 144" | 144" | NA |
| | Height: | 120" | 96" | 96" | 96" | 120" | 84" | 84" | 84" | 120" | 120" | 120" | NA |
| | Sq Ft: | 60 | 48 | 48 | 48/Shade | 60/ Shade | 70 | 70 | 70 | 120 | 120 | 60/ Shade | NA |

*Day-Night Note: Fabrics marked with an asterisk are available as only the bottom panel in a Day-Night shade.

**Longitude Note: For center opening or dual panel Longitude shades, specifications are per fabric panel. Center opening shades are available in widths up to 336". If width is greater than 185", it will be need fabricated as two shades.

ARCH & QUARTER SIZE SPECIFICATIONS

| | Movable Arch† | Stationary Arch* | Movable Qtr. Circle◇ | Stationary Qtr. Circle◇ |
|--|---------------|------------------|----------------------|-------------------------|
| Minimum Size (all Fabrics): | 18" x 9" | 18" x 9" | 9" x 9" | 9" x 9" |
| Maximum Sq. ft. (all Fabrics): | | | | |
| | 18 sq ft | 18 sq ft | 16 sq ft | 16 sq ft |
| Maximum Size (Fabric Specific): | | | | |
| D-06 • 3/4" Single Cell Semi Sheer | 72" x 36" | 72" x 36" | 48" x 48" | 48" x 48" |
| D-07 • 3/4" Single Cell Blackout | 72" x 36" | 72" x 36" | 48" x 48" | 48" x 48" |
| D-08 • 3/4" Single Cell Sheer | 72" x 36" | 72" x 36" | 48" x 48" | 48" x 48" |
| D-13/D-14/D-15 • 3/4" Single Cell Translucent | 72" x 36" | 72" x 36" | 48" x 48" | 48" x 48" |
| D-16 • 3/4" Single Cell Flame Retardant Blackout | 72" x 36" | 72" x 36" | 48" x 48" | 48" x 48" |
| D-19 • 3/4" Single Cell Semi-Sheer | 72" x 36" | 72" x 36" | 48" x 48" | 48" x 48" |
| D-20 • 3/4" Single Cell Flame Retardant Translucent | 72" x 36" | 72" x 36" | 48" x 48" | 48" x 48" |
| F-08 • 3/8" Single Cell Translucent | 72" x 36" | 72" x 36" | 48" x 48" | 48" x 48" |
| F-09 • 3/8" Single Cell Blackout | 72" x 36" | 72" x 36" | 48" x 48" | 48" x 48" |
| F-15 • 1/2" Double Cell Translucent | 72" x 36" | 72" x 36" | 48" x 48" | 48" x 48" |
| F-16 • 3/4" Single Cell Linen Translucent | 72" x 36" | 72" x 36" | 48" x 48" | 48" x 48" |
| F-17 • 3/4" Single Cell Blackout | 72" x 36" | 72" x 36" | 48" x 48" | 48" x 48" |
| F-25 • 1/2" Double Cell Textured Translucent | 72" x 36" | 72" x 36" | 48" x 48" | 48" x 48" |
| F-26 • 3/4" Single Cell Textured Translucent | 72" x 36" | 72" x 36" | 48" x 48" | 48" x 48" |
| F-27 • 3/4" Single Cell Textured Blackout | 72" x 36" | 72" x 36" | 48" x 48" | 48" x 48" |
| F-28 • 3/8" Single Cell Textured Translucent | 72" x 36" | 72" x 36" | 48" x 48" | 48" x 48" |
| F-29 • 3/8" Single Cell Textured Blackout | 72" x 36" | 72" x 36" | 48" x 48" | 48" x 48" |
| F-36 • 3/4" Single Cell Translucent | 72" x 36" | 72" x 36" | 48" x 48" | 48" x 48" |
| F-37 • 3/4" Single Cell Blackout | 72" x 36" | 72" x 36" | 48" x 48" | 48" x 48" |
| F-50 • 3/4" Single Cell Translucent | 72" x 36" | 72" x 36" | 48" x 48" | 48" x 48" |
| F-56 • 3/4" Single Cell Translucent | 72" x 36" | 72" x 36" | 48" x 48" | 48" x 48" |
| G-23/G-24/G-25 • 3/4" Single Cell Blackout | 72" x 36" | 72" x 36" | 48" x 48" | 48" x 48" |
| T-04 • 1/2" Double Cell Soft Touch Translucent | 72" x 36" | 72" x 36" | 48" x 48" | 48" x 48" |
| T-05 • 3/4" Single Cell Soft Touch Translucent | 72" x 36" | 72" x 36" | 48" x 48" | 48" x 48" |
| T-08 • 3/4" Single Cell Soft Touch Blackout | 72" x 36" | 72" x 36" | 48" x 48" | 48" x 48" |
| T-21 • 3/4" Single Cell Blackout | 72" x 36" | 72" x 36" | 48" x 48" | 48" x 48" |
| T-23 • 1/2" Double Cell Soft Touch Blackout | 72" x 36" | 72" x 36" | 48" x 48" | 48" x 48" |
| T-41 • 3/4" Single Cell Translucent | 72" x 36" | 72" x 36" | 48" x 48" | 48" x 48" |
| T-43 • 1/2" Double Cell Translucent | 72" x 36" | 72" x 36" | 48" x 48" | 48" x 48" |

† Movable Arches are only available as a Perfect Arch; height is 1/2 of width.

* A template is required for all imperfect Stationary Arches.

◇ For all Quarter Circles: the height must equal the width.

PRODUCT SPECIFICATIONS

STACKING HEIGHTS

Drop refers to shade fully extended. Stack refers to shade fully raised. Measurements do not include headrail and bottomrail. All sizes are based on standard rectangular shade specifications. 1/8

D06, D19

| | | | | |
|-------|------|------|-----|------|
| Drop | 48" | 72" | 84" | 120" |
| Stack | 1 ¼" | 1 ¾" | 2" | 3 ¼" |

D08, D09

| | | | | |
|-------|-----|------|------|------|
| Drop | 48" | 72" | 84" | 120" |
| Stack | ½" | 5/8" | 5/8" | 1" |

D07, D16, F17, F27, F37, G23, G24, G25

| | | | | |
|-------|-----|-----|--------|------|
| Drop | 48" | 72" | 84" | 120" |
| Stack | ½" | ¾" | 1 1/8" | 1" |

D20

| | | | | |
|-------|------|-----|------|------|
| Drop | 48" | 72" | 84" | 120" |
| Stack | 5/8" | ¾" | 7/8" | 1 ½" |

F08, F28

| | | | | |
|-------|-----|--------|--------|--------|
| Drop | 48" | 72" | 84" | 120" |
| Stack | ¾" | 1 1/8" | 1 3/8" | 2 1/8" |

F09, F29

| | | | | |
|-------|-----|------|--------|------|
| Drop | 48" | 72" | 84" | 120" |
| Stack | 1" | 1 ½" | 1 5/8" | 2 ¾" |

F15, F25

| | | | | |
|-------|------|-----|--------|--------|
| Drop | 48" | 72" | 84" | 120" |
| Stack | 5/8" | 1" | 1 1/8" | 1 5/8" |

T04, T43

| | | | | |
|-------|--------|--------|------|------|
| Drop | 48" | 72" | 84" | 120" |
| Stack | 2 1/8" | 3 1/8" | 3 ½" | 6" |

T05, T41

| | | | | |
|-------|-----|------|-----|------|
| Drop | 48" | 72" | 84" | 120" |
| Stack | 1" | 1 ½" | 2" | 3" |

T08, T21, T23

| | | | | |
|-------|------|-----|------|------|
| Drop | 48" | 72" | 84" | 120" |
| Stack | 1 ½" | 2" | 2 ½" | 4" |

T32, T37

| | | | | |
|-------|--------|--------|-----|--------|
| Drop | 48" | 72" | 84" | 120" |
| Stack | 2 5/8" | 3 5/8" | 4" | 6 7/8" |

PRODUCT SPECIFICATIONS

MOUNTING REQUIREMENTS & PRICING

When measuring and installing, please keep in mind the following rail measurements:

SLIM HEAD RAIL

| | |
|--|---------|
| Minimum Shallow Mounting Surface | 1/2" |
| Minimum Flush Inside Mounting Surface..... | 1/2" |
| Minimum Outside Mounting Surface..... | 3/4" |
| Depth..... | 1 7/16" |
| Height..... | 1/2" |

3/8" Single Cell Only

STANDARD HEAD RAIL

| | |
|--|--------|
| Minimum Shallow Mounting Surface | 1/2" |
| Minimum Flush Inside Mounting Surface..... | 2 1/2" |
| Minimum Outside Mounting Surface..... | 3/4" |
| Depth..... | 1 7/8" |
| Height..... | 1/2" |

All Cell Sizes Except 3/8"

CONTINUOUS CORD SYSTEM

| | |
|--|----------|
| Minimum Shallow Mounting Surface | 3/4" |
| Minimum Flush Inside Mounting Surface..... | 2" |
| Minimum Outside Mounting Surface..... | 1/2" |
| Depth..... | 1 11/16" |
| Height..... | 1 5/16" |

| Width | 24" | 30" | 36" | 42" | 48" | 54" | 60" | 66" | 72" |
|-------|-----|-----|------|------|------|------|------|------|-----|
| Add | 83 | 86 | 95 | 100 | 103 | 109 | 109 | 120 | 124 |
| Width | 84" | 96" | 108" | 120" | 132" | 144" | 156" | 174" | |
| Add | 129 | 141 | 146 | 155 | 163 | 172 | N/A | N/A | |

| Surcharge | |
|----------------|-------|
| Standard Shade | \$154 |
| TDBU Shade | \$204 |

FINISHED DIMENSIONS

INSIDE MOUNT

- Headrail will measure ordered width less 3/16"
- Fabric will measure ordered width less 3/8"

OUTSIDE MOUNT

- Headrail (endcap to endcap) will measure ordered width plus 3/16"
- Fabric will measure ordered width

EXACT

- Headrail (endcap to endcap) will measure ordered width
- Fabric will measure ordered width less 3/16"

For additional motorization options see the Motorization Price List

CORDLESS LIFT SYSTEM

| | |
|--|----------|
| Minimum Shallow Mounting Surface | 3/4" |
| Minimum Flush Inside Mounting Surface..... | 2" |
| Minimum Outside Mounting Surface..... | 1/2" |
| Depth..... | 1 11/16" |
| Height..... | 1 5/16" |

| Width | 24" | 30" | 36" | 42" | 48" | 54" | 60" | 66" | 72" |
|-------|-----|-----|------|------|------|------|------|------|-----|
| Add | 91 | 98 | 106 | 112 | 114 | 117 | 120 | 132 | 136 |
| Width | 84" | 96" | 108" | 120" | 132" | 144" | 156" | 174" | |
| Add | 144 | 155 | 162 | 170 | N/A | N/A | N/A | N/A | |

| Surcharge | |
|----------------|-------|
| Standard Shade | \$165 |
| TDBU Shade | \$193 |

REELIFT HEAD RAIL 120 VOLT & 24 VOLT LIFT SYSTEM

| | |
|--|----------|
| Minimum Shallow Mounting Surface | 1 1/2" |
| Minimum Flush Inside Mounting Surface..... | 2 11/16" |
| Minimum Outside Mounting Surface..... | 1 1/4" |
| Depth..... | 2 7/16" |
| Height..... | 2 5/8" |

WIDTH LIMIT

SIDE MOUNT BRACKETS

There is a recommended 48" width limit on shades installed with side mount brackets.

PRICE CHART 1

PRICE CHART 1 STANDARD RECTANGULAR

STANDARD RECTANGULAR

T-01 • 9/16" SINGLE CELL POINTBOND FABRIC

| | | ← Width → | | | | | | | | | | | | | | |
|-------------|------|-----------|-----|-----|-----|-----|-----|-----|------|------|------|------|------|------|------|------|
| | | 24" | 30" | 36" | 42" | 48" | 54" | 60" | 66" | 72" | 84" | 96" | 108" | 120" | 132" | 144" |
| Height ↓ | 36" | 194 | 212 | 238 | 269 | 300 | 319 | 346 | 373 | 402 | 459 | 516 | 637 | 691 | 747 | 802 |
| | 42" | 204 | 228 | 260 | 291 | 319 | 351 | 381 | 409 | 444 | 505 | 556 | 700 | 765 | 832 | 884 |
| | 48" | 214 | 247 | 279 | 317 | 346 | 381 | 413 | 455 | 483 | 554 | 625 | 762 | 825 | 901 | 965 |
| | 54" | 229 | 266 | 300 | 338 | 373 | 409 | 451 | 487 | 522 | 598 | 680 | 820 | 904 | 972 | 1043 |
| | 60" | 242 | 278 | 319 | 361 | 405 | 442 | 483 | 522 | 571 | 649 | 744 | 883 | 963 | 1043 | 1124 |
| | 66" | 253 | 297 | 343 | 381 | 428 | 473 | 522 | 558 | 604 | 692 | 792 | 944 | 1032 | 1119 | 1218 |
| | 72" | 269 | 313 | 361 | 406 | 457 | 504 | 549 | 597 | 648 | 745 | 853 | 1018 | 1098 | 1194 | 1290 |
| | 78" | 281 | 334 | 380 | 429 | 491 | 537 | 592 | 636 | 686 | 792 | 904 | 1073 | 1166 | 1268 | 1382 |
| | 84" | 291 | 343 | 396 | 449 | 514 | 570 | 621 | 676 | 736 | 833 | 955 | 1130 | 1239 | 1359 | 1454 |
| | 90" | 305 | 361 | 420 | 476 | 542 | 597 | 653 | 717 | 770 | 883 | 1025 | 1194 | 1307 | 1422 | 1534 |
| | 96" | 317 | 377 | 436 | 499 | 566 | 629 | 689 | 748 | 810 | 930 | 1066 | 1258 | 1375 | 1494 | 1617 |
| | 102" | 334 | 396 | 462 | 530 | 598 | 670 | 730 | 797 | 862 | 999 | 1138 | 1330 | 1463 | 1590 | 1720 |
| 108" | 361 | 436 | 504 | 572 | 651 | 725 | 797 | 873 | 941 | 1084 | 1241 | 1461 | 1591 | 1734 | 1898 | |
| 120" | 389 | 462 | 545 | 621 | 710 | 785 | 862 | 939 | 1020 | 1179 | 1345 | 1570 | 1720 | 1881 | 2055 | |

Refer to the Shade Size Specifications chart on page 7 for any size limitations or exclusions by fabric or operating system

For more Options please see page 10

SPECIALTY SHADE OPTION SURCHARGES

| | |
|--|--|
| Standard Continuous Cord | \$154 |
| Two-on-One Headrail..... | Price as two individual shades, then add \$121 |
| Top-Down/Bottom-Up | Price as a standard shade, then add \$163 |
| Top-Down Only Shades | Price as a standard shade, then add \$163 |
| Day-Night Shades | Price each fabric as a separate shade and add together |
| Top-Down/Bottom-Up Cordless | Add \$193 to the Standard Cordless Pricing |
| Top-Down/Bottom-Up Continuous Cord | Add \$204 to Standard Continuous Cord Pricing |
| Cut-Outs..... | \$89 per side (subject to approval)* |
| Lift & Lock Cordless | Free Upgrade |
| Standard Cordless | \$165 |
| Top-Down/Bottom-Up Lift & Lock Cordless..... | Add \$165 |

*There are no limits on cut-out heights. There are, however limits on cut-out widths. Less than 18" shade means 3" max width cut-out. More than 18" shade means 5" max width cut-out

**Standard Continuous Cord for Top-Down/Bottom-Up add \$124 to Standard Continuous Cord System surcharge

Prices subject to change without notice

PRICE CHART 2

PRICE CHART 2

STANDARD RECTANGULAR

T-03 • 9/16" SINGLE CELL SOFT TOUCH TRANSLUCENT, T-05 • 3/4" SINGLE CELL SOFT TOUCH TRANSLUCENT

| | ← Width → | | | | | | | | | | | | | | |
|------|-----------|-----|-----|-----|-----|-----|-----|------|------|------|------|------|------|------|------|
| | 24" | 30" | 36" | 42" | 48" | 54" | 60" | 66" | 72" | 84" | 96" | 108" | 120" | 132" | 144" |
| 36" | 223 | 244 | 274 | 310 | 345 | 367 | 399 | 428 | 461 | 526 | 593 | 734 | 796 | 858 | 922 |
| 42" | 234 | 262 | 299 | 337 | 367 | 405 | 440 | 470 | 511 | 579 | 638 | 805 | 877 | 954 | 1017 |
| 48" | 247 | 283 | 319 | 363 | 399 | 440 | 477 | 522 | 556 | 635 | 720 | 874 | 949 | 1037 | 1108 |
| 54" | 263 | 305 | 345 | 385 | 428 | 470 | 517 | 561 | 600 | 689 | 784 | 944 | 1040 | 1119 | 1202 |
| 60" | 279 | 318 | 367 | 414 | 467 | 508 | 556 | 600 | 656 | 746 | 853 | 1015 | 1106 | 1202 | 1292 |
| 66" | 292 | 341 | 394 | 440 | 493 | 543 | 601 | 642 | 696 | 797 | 909 | 1084 | 1186 | 1286 | 1401 |
| 72" | 310 | 357 | 414 | 467 | 524 | 578 | 632 | 688 | 745 | 855 | 981 | 1170 | 1262 | 1371 | 1482 |
| 78" | 322 | 381 | 436 | 494 | 564 | 614 | 680 | 731 | 788 | 909 | 1039 | 1236 | 1339 | 1461 | 1589 |
| 84" | 337 | 394 | 457 | 516 | 592 | 653 | 714 | 777 | 844 | 956 | 1098 | 1300 | 1426 | 1562 | 1670 |
| 90" | 348 | 414 | 483 | 545 | 621 | 688 | 752 | 825 | 884 | 1015 | 1177 | 1371 | 1503 | 1633 | 1766 |
| 96" | 365 | 433 | 501 | 572 | 651 | 722 | 792 | 861 | 931 | 1067 | 1227 | 1447 | 1581 | 1718 | 1862 |
| 102" | 381 | 457 | 533 | 610 | 689 | 772 | 838 | 915 | 992 | 1147 | 1307 | 1528 | 1685 | 1829 | 1977 |
| 108" | 414 | 500 | 578 | 658 | 748 | 833 | 915 | 1004 | 1082 | 1247 | 1429 | 1680 | 1830 | 1997 | 2182 |
| 120" | 447 | 534 | 627 | 714 | 816 | 901 | 992 | 1080 | 1171 | 1355 | 1547 | 1806 | 1977 | 2163 | 2363 |

Refer to the Shade Size Specifications chart on page 7 for any size limitations or exclusions by fabric or operating system

For more Options please see page 10

SPECIALTY SHADE OPTION SURCHARGES

| | |
|--|--|
| Standard Continuous Cord | \$154 |
| Two-on-One Headrail..... | Price as two individual shades, then add \$121 |
| Top-Down/Bottom-Up | Price as a standard shade, then add \$163 |
| Top-Down Only Shades | Price as a standard shade, then add \$163 |
| Day-Night Shades | Price each fabric as a separate shade and add together |
| Top-Down/Bottom-Up Cordless | Add \$193 to the Standard Cordless Pricing |
| Top-Down/Bottom-Up Continuous Cord..... | Add \$204 to Standard Continuous Cord Pricing |
| Cut-Outs..... | \$89 per side (subject to approval)* |
| Lift & Lock Cordless | Free Upgrade |
| Standard Cordless | \$165 |
| Top-Down/Bottom-Up Lift & Lock Cordless..... | Add \$165 |

*There are no limits on cut-out heights. There are, however limits on cut-out widths. Less than 18" shade means 3" max width cut-out. More than 18" shade means 5" max width cut-out

**Standard Continuous Cord for Top-Down/Bottom-Up add \$124 to Standard Continuous Cord System surcharge

Prices subject to change without notice

PRICE CHART 3

PRICE CHART 3

STANDARD RECTANGULAR

**F-26 • 3/4" SINGLE CELL TEXTURED TRANSLUCENT,
 F-28 • 3/8" SINGLE CELL TEXTURED TRANSLUCENT,
 F-56 • 3/8" SINGLE CELL TRANSLUCENT,
 T-04 • 1/2" DOUBLE CELL SOFT TOUCH TRANSLUCENT**

| | ← Width → | | | | | | | | | | | | | | | | |
|------|-----------|-----|-----|-----|-----|-----|------|------|------|------|------|------|------|------|------|------|------|
| | 24" | 30" | 36" | 42" | 48" | 54" | 60" | 66" | 72" | 84" | 96" | 108" | 120" | 132" | 144" | 156" | 174" |
| 36" | 242 | 267 | 300 | 338 | 374 | 399 | 435 | 467 | 502 | 574 | 644 | 798 | 865 | 933 | 1004 | 1080 | 1206 |
| 42" | 253 | 285 | 325 | 363 | 399 | 442 | 478 | 513 | 556 | 632 | 697 | 875 | 955 | 1041 | 1105 | 1188 | 1329 |
| 48" | 269 | 308 | 348 | 395 | 435 | 478 | 516 | 566 | 602 | 690 | 785 | 952 | 1031 | 1128 | 1206 | 1300 | 1456 |
| 54" | 286 | 330 | 373 | 421 | 467 | 513 | 563 | 610 | 652 | 750 | 850 | 1026 | 1130 | 1217 | 1305 | 1410 | 1578 |
| 60" | 303 | 346 | 399 | 451 | 508 | 554 | 602 | 652 | 713 | 810 | 929 | 1104 | 1203 | 1305 | 1404 | 1517 | 1701 |
| 66" | 317 | 370 | 427 | 478 | 537 | 590 | 653 | 699 | 757 | 867 | 988 | 1180 | 1291 | 1399 | 1525 | 1633 | 1833 |
| 72" | 338 | 389 | 451 | 510 | 571 | 630 | 686 | 747 | 809 | 930 | 1066 | 1272 | 1372 | 1490 | 1613 | 1743 | 1957 |
| 78" | 349 | 415 | 476 | 538 | 613 | 670 | 740 | 796 | 856 | 988 | 1130 | 1342 | 1457 | 1589 | 1729 | 1853 | 2079 |
| 84" | 363 | 427 | 498 | 561 | 643 | 710 | 776 | 844 | 917 | 1042 | 1195 | 1416 | 1549 | 1701 | 1817 | 1965 | 2204 |
| 90" | 380 | 451 | 525 | 593 | 676 | 747 | 817 | 896 | 962 | 1104 | 1280 | 1490 | 1635 | 1775 | 1919 | 2077 | 2331 |
| 96" | 396 | 472 | 546 | 622 | 708 | 787 | 858 | 935 | 1012 | 1162 | 1335 | 1571 | 1718 | 1869 | 2023 | 2191 | 2459 |
| 102" | 415 | 498 | 578 | 664 | 750 | 840 | 912 | 995 | 1078 | 1248 | 1422 | 1664 | 1829 | 1988 | 2151 | 2331 | 2618 |
| 108" | 451 | 543 | 630 | 717 | 812 | 907 | 995 | 1091 | 1175 | 1356 | 1553 | 1826 | 1989 | 2170 | 2372 | 2541 | 2857 |
| 120" | 486 | 580 | 681 | 776 | 887 | 983 | 1078 | 1171 | 1273 | 1473 | 1682 | 1962 | 2151 | 2351 | 2568 | 2754 | 3095 |

Refer to the Shade Size Specifications chart on page 7 for any size limitations or exclusions by fabric or operating system

For more Options please see page 10

SPECIALTY SHADE OPTION SURCHARGES

| | |
|--|--|
| Standard Continuous Cord | \$154 |
| Two-on-One Headrail..... | Price as two individual shades, then add \$121 |
| Top-Down/Bottom-Up | Price as a standard shade, then add \$163 |
| Top-Down Only Shades | Price as a standard shade, then add \$163 |
| Day-Night Shades | Price each fabric as a separate shade and add together |
| Top-Down/Bottom-Up Cordless | Add \$193 to the Standard Cordless Pricing |
| Top-Down/Bottom-Up Continuous Cord..... | Add \$204 to Standard Continuous Cord Pricing |
| Cut-Outs..... | \$89 per side (subject to approval)* |
| Lift & Lock Cordless | Free Upgrade |
| Standard Cordless | \$165 |
| Top-Down/Bottom-Up Lift & Lock Cordless..... | Add \$165 |

*There are no limits on cut-out heights. There are, however limits on cut-out widths. Less than 18" shade means 3" max width cut-out. More than 18" shade means 5" max width cut-out

**Standard Continuous Cord for Top-Down/Bottom-Up add \$124 to Standard Continuous Cord System surcharge

Prices subject to change without notice

PRICE CHART 4

PRICE CHART 4

STANDARD RECTANGULAR

**F-08 • 3/8" SINGLE CELL TRANSLUCENT,
 F-25 • 1/2" DOUBLE CELL TEXTURED TRANSLUCENT,
 T-08 • 3/4" SINGLE CELL SOFT TOUCH BLACKOUT,
 T-23 • 1/2" DOUBLE CELL SOFT TOUCH BLACKOUT
 F-16 • 3/4" SINGLE CELL LINEN TRANSLUCENT ESSENTIALS *
 F-17 • 3/4" SINGLE CELL BLACKOUT ESSENTIALS ***

| | ← Width → | | | | | | | | | | | | | | | | |
|------|-----------|-----|-----|-----|-----|------|------|------|------|------|------|------|------|------|------|------|------|
| | 24" | 30" | 36" | 42" | 48" | 54" | 60" | 66" | 72" | 84" | 96" | 108" | 120" | 132" | 144" | 156" | 174" |
| 36" | 251 | 277 | 310 | 349 | 389 | 415 | 451 | 486 | 523 | 598 | 670 | 830 | 900 | 971 | 1043 | 1122 | 1254 |
| 42" | 266 | 299 | 338 | 379 | 415 | 458 | 499 | 533 | 580 | 656 | 724 | 911 | 993 | 1081 | 1148 | 1238 | 1382 |
| 48" | 281 | 322 | 378 | 411 | 451 | 499 | 538 | 590 | 627 | 718 | 813 | 989 | 1073 | 1171 | 1256 | 1353 | 1514 |
| 54" | 300 | 343 | 388 | 437 | 486 | 533 | 586 | 633 | 678 | 779 | 884 | 1066 | 1175 | 1263 | 1359 | 1467 | 1643 |
| 60" | 316 | 359 | 415 | 470 | 530 | 574 | 627 | 678 | 741 | 843 | 965 | 1147 | 1251 | 1359 | 1461 | 1577 | 1768 |
| 66" | 330 | 385 | 446 | 499 | 558 | 614 | 678 | 729 | 788 | 901 | 1028 | 1226 | 1342 | 1456 | 1584 | 1701 | 1908 |
| 72" | 349 | 405 | 470 | 531 | 593 | 654 | 713 | 778 | 842 | 967 | 1108 | 1323 | 1429 | 1550 | 1677 | 1813 | 2033 |
| 78" | 363 | 429 | 494 | 560 | 637 | 698 | 769 | 827 | 890 | 1028 | 1176 | 1397 | 1514 | 1650 | 1798 | 1927 | 2163 |
| 84" | 379 | 445 | 516 | 582 | 669 | 739 | 808 | 876 | 954 | 1083 | 1243 | 1472 | 1611 | 1768 | 1888 | 2042 | 2292 |
| 90" | 395 | 470 | 545 | 616 | 702 | 778 | 849 | 931 | 1000 | 1147 | 1331 | 1550 | 1702 | 1847 | 1996 | 2160 | 2424 |
| 96" | 413 | 489 | 569 | 648 | 736 | 817 | 894 | 972 | 1052 | 1209 | 1390 | 1635 | 1787 | 1943 | 2105 | 2277 | 2559 |
| 102" | 433 | 516 | 601 | 689 | 779 | 873 | 951 | 1033 | 1120 | 1297 | 1479 | 1729 | 1902 | 2068 | 2236 | 2424 | 2722 |
| 108" | 470 | 565 | 654 | 746 | 845 | 943 | 1033 | 1136 | 1223 | 1411 | 1614 | 1901 | 2071 | 2255 | 2467 | 2644 | 2972 |
| 120" | 506 | 602 | 709 | 808 | 923 | 1020 | 1120 | 1219 | 1324 | 1532 | 1748 | 2041 | 2236 | 2446 | 2671 | 2862 | 3221 |

Refer to the Shade Size Specifications chart on page 7 for any size limitations or exclusions by fabric or operating system

For more Options please see page 10

SPECIALTY SHADE OPTION SURCHARGES

| | |
|--|--|
| Standard Continuous Cord | \$154 |
| Two-on-One Headrail..... | Price as two individual shades, then add \$121 |
| Top-Down/Bottom-Up | Price as a standard shade, then add \$163 |
| Top-Down Only Shades | Price as a standard shade, then add \$163 |
| Day-Night Shades | Price each fabric as a separate shade and add together |
| Top-Down/Bottom-Up Cordless | Add \$193 to the Standard Cordless Pricing |
| Top-Down/Bottom-Up Continuous Cord..... | Add \$204 to Standard Continuous Cord Pricing |
| Cut-Outs..... | \$89 per side (subject to approval)* |
| Lift & Lock Cordless | Free Upgrade |
| Standard Cordless | \$165 |
| Top-Down/Bottom-Up Lift & Lock Cordless..... | Add \$165 |

*There are no limits on cut-out heights. There are, however limits on cut-out widths. Less than 18" shade means 3" max width cut-out. More than 18" shade means 5" max width cut-out

**Standard Continuous Cord for Top-Down/Bottom-Up add \$124 to Standard Continuous Cord System surcharge

Prices subject to change without notice

PRICE CHART 5

PRICE CHART 5

STANDARD RECTANGULAR

**D-07 • 3/4" SINGLE CELL BLACKOUT,
 F-15 • 1/2" DOUBLE CELL TRANSLUCENT,
 F-16, F-36 • 3/4" SINGLE CELL TRANSLUCENT,
 F-27 • 3/4" SINGLE CELL TEXTURED BLACKOUT,
 T-06 • 9/16" SINGLE CELL SOFT TOUCH BLACKOUT**

| | ← Width → | | | | | | | | | | | | | | | | |
|------|-----------|-----|-----|-----|-----|------|------|------|------|------|------|------|------|------|------|------|------|
| | 24" | 30" | 36" | 42" | 48" | 54" | 60" | 66" | 72" | 84" | 96" | 108" | 120" | 132" | 144" | 156" | 174" |
| 36" | 260 | 286 | 323 | 363 | 403 | 429 | 468 | 505 | 542 | 621 | 697 | 862 | 933 | 1009 | 1083 | 1164 | 1303 |
| 42" | 277 | 308 | 349 | 393 | 429 | 477 | 516 | 555 | 601 | 681 | 753 | 945 | 1029 | 1122 | 1194 | 1283 | 1434 |
| 48" | 291 | 334 | 374 | 426 | 468 | 516 | 558 | 612 | 652 | 746 | 845 | 1028 | 1115 | 1218 | 1303 | 1403 | 1571 |
| 54" | 310 | 357 | 403 | 454 | 505 | 555 | 610 | 657 | 706 | 809 | 917 | 1107 | 1219 | 1313 | 1411 | 1521 | 1705 |
| 60" | 327 | 373 | 429 | 486 | 549 | 596 | 652 | 706 | 770 | 874 | 1003 | 1191 | 1298 | 1411 | 1517 | 1638 | 1837 |
| 66" | 343 | 399 | 465 | 516 | 579 | 638 | 706 | 755 | 817 | 935 | 1067 | 1273 | 1394 | 1511 | 1645 | 1766 | 1980 |
| 72" | 363 | 421 | 486 | 550 | 616 | 680 | 740 | 808 | 873 | 1004 | 1151 | 1374 | 1482 | 1610 | 1741 | 1881 | 2111 |
| 78" | 379 | 449 | 513 | 580 | 659 | 724 | 798 | 857 | 926 | 1067 | 1220 | 1450 | 1573 | 1713 | 1865 | 1986 | 2247 |
| 84" | 393 | 462 | 537 | 603 | 696 | 768 | 838 | 911 | 992 | 1125 | 1290 | 1528 | 1672 | 1836 | 1961 | 2120 | 2379 |
| 90" | 411 | 486 | 566 | 641 | 731 | 808 | 882 | 967 | 1039 | 1191 | 1383 | 1610 | 1766 | 1918 | 2073 | 2243 | 2516 |
| 96" | 427 | 508 | 589 | 674 | 764 | 849 | 929 | 1011 | 1093 | 1257 | 1441 | 1701 | 1857 | 2018 | 2184 | 2365 | 2656 |
| 102" | 449 | 537 | 624 | 715 | 809 | 906 | 986 | 1075 | 1163 | 1346 | 1535 | 1795 | 1975 | 2145 | 2323 | 2516 | 2826 |
| 108" | 486 | 588 | 680 | 774 | 877 | 981 | 1075 | 1180 | 1268 | 1463 | 1677 | 1973 | 2150 | 2343 | 2562 | 2744 | 3086 |
| 120" | 525 | 625 | 736 | 838 | 960 | 1059 | 1163 | 1265 | 1375 | 1591 | 1818 | 2119 | 2323 | 2540 | 2775 | 2974 | 3344 |

Refer to the Shade Size Specifications chart on page 7 for any size limitations or exclusions by fabric or operating system

For more Options please see page 10

SPECIALTY SHADE OPTION SURCHARGES

| | |
|--|--|
| Standard Continuous Cord | \$154 |
| Two-on-One Headrail..... | Price as two individual shades, then add \$121 |
| Top-Down/Bottom-Up | Price as a standard shade, then add \$163 |
| Top-Down Only Shades | Price as a standard shade, then add \$163 |
| Day-Night Shades | Price each fabric as a separate shade and add together |
| Top-Down/Bottom-Up Cordless | Add \$193 to the Standard Cordless Pricing |
| Top-Down/Bottom-Up Continuous Cord | Add \$204 to Standard Continuous Cord Pricing |
| Cut-Outs..... | \$89 per side (subject to approval)* |
| Lift & Lock Cordless | Free Upgrade |
| Standard Cordless | \$165 |
| Top-Down/Bottom-Up Lift & Lock Cordless..... | Add \$165 |

*There are no limits on cut-out heights. There are, however limits on cut-out widths. Less than 18" shade means 3" max width cut-out. More than 18" shade means 5" max width cut-out

**Standard Continuous Cord for Top-Down/Bottom-Up add \$124 to Standard Continuous Cord System surcharge

Prices subject to change without notice

PRICE CHART 6

PRICE CHART 6

STANDARD RECTANGULAR

**D-06 • 3/4" SINGLE CELL SEMI SHEER,
 D-13, D-14, D-15 • 3/4" SINGLE CELL TRANSLUCENT,
 D-16 • 3/4" SINGLE CELL FLAME RETARDANT BLACKOUT,
 D-20 • 3/4" SINGLE CELL FLAME RETARDANT TRANSLUCENT,
 F-09 • 3/8" SINGLE CELL BLACKOUT,
 F-17 • 3/4" SINGLE CELL BLACKOUT,
 T-21 • 3/4" SINGLE CELL BI-LAM BLACKOUT
 T-21L • 3/4" SINGLE CELL BI-LAM BLACKOUT LINEN**

| | ← Width → | | | | | | | | | | | | | | | | |
|------|-----------|-----|-----|-----|------|------|------|------|------|------|------|------|------|------|------|------|------|
| | 24" | 30" | 36" | 42" | 48" | 54" | 60" | 66" | 72" | 84" | 96" | 108" | 120" | 132" | 144" | 156" | 174" |
| 36" | 308 | 340 | 381 | 429 | 479 | 511 | 555 | 597 | 643 | 734 | 824 | 1023 | 1106 | 1195 | 1282 | 1382 | 1544 |
| 42" | 326 | 363 | 414 | 466 | 511 | 564 | 612 | 654 | 712 | 808 | 889 | 1120 | 1223 | 1330 | 1414 | 1521 | 1701 |
| 48" | 345 | 394 | 445 | 506 | 555 | 612 | 660 | 728 | 773 | 884 | 1001 | 1218 | 1319 | 1441 | 1544 | 1664 | 1864 |
| 54" | 366 | 422 | 478 | 538 | 597 | 654 | 721 | 779 | 833 | 960 | 1087 | 1313 | 1447 | 1555 | 1671 | 1804 | 2021 |
| 60" | 387 | 443 | 511 | 575 | 651 | 707 | 773 | 833 | 912 | 1037 | 1187 | 1412 | 1538 | 1671 | 1799 | 1942 | 2175 |
| 66" | 405 | 475 | 549 | 612 | 686 | 756 | 835 | 894 | 968 | 1107 | 1263 | 1507 | 1653 | 1790 | 1949 | 2093 | 2347 |
| 72" | 429 | 499 | 575 | 651 | 730 | 805 | 876 | 955 | 1032 | 1188 | 1362 | 1627 | 1758 | 1908 | 2062 | 2230 | 2503 |
| 78" | 446 | 532 | 610 | 688 | 785 | 856 | 945 | 1019 | 1097 | 1263 | 1448 | 1716 | 1864 | 2031 | 2209 | 2371 | 2660 |
| 84" | 466 | 549 | 635 | 717 | 823 | 908 | 993 | 1080 | 1175 | 1334 | 1528 | 1810 | 1980 | 2175 | 2325 | 2514 | 2820 |
| 90" | 486 | 575 | 670 | 759 | 866 | 955 | 1044 | 1146 | 1230 | 1412 | 1638 | 1908 | 2094 | 2272 | 2455 | 2658 | 2983 |
| 96" | 506 | 601 | 699 | 797 | 905 | 1005 | 1100 | 1198 | 1296 | 1487 | 1709 | 2013 | 2199 | 2392 | 2590 | 2802 | 3148 |
| 102" | 533 | 635 | 740 | 847 | 960 | 1073 | 1168 | 1273 | 1378 | 1594 | 1819 | 2129 | 2340 | 2544 | 2750 | 2981 | 3349 |
| 108" | 575 | 696 | 805 | 916 | 1041 | 1161 | 1273 | 1397 | 1503 | 1734 | 1985 | 2337 | 2547 | 2778 | 3035 | 3253 | 3657 |
| 120" | 621 | 741 | 872 | 993 | 1137 | 1256 | 1378 | 1499 | 1630 | 1886 | 2152 | 2511 | 2750 | 3010 | 3286 | 3523 | 3963 |

Refer to the Shade Size Specifications chart on page 7 for any size limitations or exclusions by fabric or operating system

For more Options please see page 10

SPECIALTY SHADE OPTION SURCHARGES

| | |
|---|--|
| Standard Continuous Cord | \$154 |
| Two-on-One Headrail | Price as two individual shades, then add \$121 |
| Top-Down/Bottom-Up | Price as a standard shade, then add \$163 |
| Top-Down Only Shades | Price as a standard shade, then add \$163 |
| Day-Night Shades | Price each fabric as a separate shade and add together |
| Top-Down/Bottom-Up Cordless | Add \$193 to the Standard Cordless Pricing |
| Top-Down/Bottom-Up Continuous Cord | Add \$204 to Standard Continuous Cord Pricing |
| Cut-Outs | \$89 per side (subject to approval)* |
| Lift & Lock Cordless | Free Upgrade |
| Standard Cordless | \$165 |
| Top-Down/Bottom-Up Lift & Lock Cordless | Add \$165 |

*There are no limits on cut-out heights. There are, however limits on cut-out widths. Less than 18" shade means 3" max width cut-out. More than 18" shade means 5" max width cut-out

**Standard Continuous Cord for Top-Down/Bottom-Up add \$124 to Standard Continuous Cord System surcharge

Prices subject to change without notice

PRICE CHART 7

PRICE CHART 7

STANDARD RECTANGULAR

**D-08, D-09 • 3/4" SINGLE CELL KNITTED SHEER,
F-37 • 3/4" SINGLE CELL BLACKOUT,
G-23, G-24, G-25 • 3/4" SINGLE CELL BLACKOUT,
H-20 • 3/4" ULTRA SOFT CELL TRANSLUCENT**

| | ← Width → | | | | | | | | | | | | | | | | |
|------|-----------|-----|-----|------|------|------|------|------|------|------|------|------|------|------|------|------|------|
| | 24" | 30" | 36" | 42" | 48" | 54" | 60" | 66" | 72" | 84" | 96" | 108" | 120" | 132" | 144" | 156" | 174" |
| 36" | 339 | 373 | 420 | 475 | 527 | 564 | 611 | 657 | 708 | 809 | 907 | 1124 | 1219 | 1314 | 1411 | 1518 | 1696 |
| 42" | 358 | 401 | 456 | 513 | 564 | 622 | 674 | 720 | 784 | 888 | 979 | 1234 | 1344 | 1460 | 1554 | 1674 | 1869 |
| 48" | 380 | 432 | 490 | 559 | 611 | 674 | 729 | 798 | 850 | 972 | 1103 | 1339 | 1452 | 1586 | 1697 | 1830 | 2049 |
| 54" | 403 | 467 | 526 | 592 | 657 | 720 | 794 | 856 | 917 | 1053 | 1196 | 1443 | 1589 | 1711 | 1837 | 1984 | 2221 |
| 60" | 426 | 487 | 564 | 634 | 714 | 778 | 850 | 917 | 1003 | 1141 | 1306 | 1553 | 1693 | 1837 | 1976 | 2133 | 2391 |
| 66" | 447 | 522 | 602 | 674 | 756 | 831 | 919 | 985 | 1066 | 1219 | 1390 | 1659 | 1817 | 1968 | 2142 | 2299 | 2579 |
| 72" | 475 | 547 | 634 | 715 | 801 | 887 | 965 | 1051 | 1136 | 1307 | 1498 | 1789 | 1931 | 2097 | 2266 | 2449 | 2752 |
| 78" | 492 | 585 | 671 | 759 | 861 | 942 | 1039 | 1118 | 1205 | 1390 | 1592 | 1890 | 2050 | 2232 | 2430 | 2605 | 2926 |
| 84" | 513 | 602 | 699 | 791 | 906 | 999 | 1092 | 1187 | 1291 | 1466 | 1681 | 1989 | 2180 | 2391 | 2555 | 2761 | 3100 |
| 90" | 537 | 634 | 740 | 833 | 951 | 1051 | 1149 | 1259 | 1352 | 1553 | 1800 | 2097 | 2302 | 2499 | 2699 | 2924 | 3278 |
| 96" | 559 | 660 | 769 | 876 | 996 | 1106 | 1209 | 1315 | 1425 | 1636 | 1878 | 2211 | 2417 | 2631 | 2846 | 3082 | 3459 |
| 102" | 583 | 699 | 813 | 932 | 1053 | 1181 | 1284 | 1401 | 1515 | 1756 | 1999 | 2340 | 2573 | 2796 | 3025 | 3278 | 3681 |
| 108" | 634 | 766 | 887 | 1008 | 1144 | 1275 | 1401 | 1536 | 1655 | 1909 | 2184 | 2569 | 2799 | 3052 | 3338 | 3575 | 4018 |
| 120" | 685 | 816 | 959 | 1092 | 1249 | 1381 | 1515 | 1652 | 1792 | 2071 | 2368 | 2759 | 3025 | 3308 | 3614 | 3872 | 4355 |

Refer to the Shade Size Specifications chart on page 7 for any size limitations or exclusions by fabric or operating system

For more Options please see page 10

SPECIALTY SHADE OPTION SURCHARGES

| | |
|--|--|
| Standard Continuous Cord | \$154 |
| Two-on-One Headrail..... | Price as two individual shades, then add \$121 |
| Top-Down/Bottom-Up | Price as a standard shade, then add \$163 |
| Top-Down Only Shades | Price as a standard shade, then add \$163 |
| Day-Night Shades | Price each fabric as a separate shade and add together |
| Top-Down/Bottom-Up Cordless | Add \$193 to the Standard Cordless Pricing |
| Top-Down/Bottom-Up Continuous Cord..... | Add \$204 to Standard Continuous Cord Pricing |
| Cut-Outs..... | \$89 per side (subject to approval)* |
| Lift & Lock Cordless | Free Upgrade |
| Standard Cordless | \$165 |
| Top-Down/Bottom-Up Lift & Lock Cordless..... | Add \$165 |

*There are no limits on cut-out heights. There are, however limits on cut-out widths. Less than 18" shade means 3" max width cut-out. More than 18" shade means 5" max width cut-out

**Standard Continuous Cord for Top-Down/Bottom-Up add \$124 to Standard Continuous Cord System surcharge

Prices subject to change without notice

PRICE CHART 8

PRICE CHART 8

STANDARD RECTANGULAR

**D-21 • 3/8" SINGLE CELL FLAME RETARDANT TRANSLUCENT,
G-03 • 3/4" SINGLE CELL WOVEN TRANSLUCENT,
G-04 • 3/4" SINGLE CELL WOVEN BLACKOUT**

| | ← Width → | | | | | | | | | | | | | | | | |
|------|-----------|-----|------|------|------|------|------|------|------|------|------|------|------|------|------|------|------|
| | 24" | 30" | 36" | 42" | 48" | 54" | 60" | 66" | 72" | 84" | 96" | 108" | 120" | 132" | 144" | 156" | 174" |
| 36" | 385 | 425 | 477 | 538 | 598 | 637 | 692 | 746 | 802 | 917 | 1028 | 1276 | 1383 | 1491 | 1603 | 1727 | 1929 |
| 42" | 406 | 455 | 516 | 581 | 637 | 707 | 765 | 818 | 889 | 1010 | 1111 | 1400 | 1527 | 1661 | 1766 | 1903 | 2126 |
| 48" | 428 | 492 | 557 | 632 | 692 | 765 | 825 | 906 | 965 | 1105 | 1252 | 1520 | 1650 | 1802 | 1929 | 2079 | 2329 |
| 54" | 458 | 530 | 596 | 673 | 746 | 818 | 900 | 972 | 1042 | 1198 | 1359 | 1639 | 1806 | 1943 | 2087 | 2254 | 2525 |
| 60" | 483 | 555 | 637 | 721 | 812 | 883 | 965 | 1042 | 1140 | 1295 | 1482 | 1763 | 1922 | 2087 | 2248 | 2427 | 2719 |
| 66" | 506 | 592 | 684 | 765 | 856 | 944 | 1044 | 1117 | 1212 | 1385 | 1581 | 1885 | 2064 | 2237 | 2435 | 2614 | 2933 |
| 72" | 538 | 622 | 721 | 812 | 911 | 1008 | 1097 | 1195 | 1291 | 1485 | 1704 | 2033 | 2196 | 2386 | 2578 | 2787 | 3127 |
| 78" | 558 | 664 | 761 | 858 | 979 | 1071 | 1183 | 1272 | 1370 | 1581 | 1807 | 2149 | 2331 | 2539 | 2763 | 2963 | 3325 |
| 84" | 581 | 684 | 794 | 896 | 1027 | 1136 | 1241 | 1348 | 1470 | 1667 | 1910 | 2262 | 2477 | 2717 | 2903 | 3141 | 3524 |
| 90" | 609 | 721 | 838 | 946 | 1081 | 1195 | 1305 | 1432 | 1536 | 1763 | 2046 | 2386 | 2616 | 2840 | 3069 | 3338 | 3728 |
| 96" | 633 | 753 | 873 | 997 | 1130 | 1257 | 1374 | 1495 | 1619 | 1858 | 2134 | 2515 | 2748 | 2990 | 3236 | 3504 | 3934 |
| 102" | 664 | 794 | 924 | 1059 | 1198 | 1340 | 1459 | 1591 | 1721 | 1996 | 2273 | 2659 | 2923 | 3178 | 3440 | 3726 | 4187 |
| 108" | 721 | 869 | 1008 | 1144 | 1300 | 1450 | 1591 | 1746 | 1880 | 2169 | 2482 | 2921 | 3182 | 3469 | 3793 | 4066 | 4570 |
| 120" | 778 | 928 | 1088 | 1241 | 1418 | 1568 | 1721 | 1876 | 2037 | 2357 | 2690 | 3138 | 3440 | 3762 | 4109 | 4403 | 4952 |

Refer to the Shade Size Specifications chart on page 7 for any size limitations or exclusions by fabric or operating system

For more Options please see page 10

SPECIALTY SHADE OPTION SURCHARGES

| | |
|--|--|
| Standard Continuous Cord | \$154 |
| Two-on-One Headrail..... | Price as two individual shades, then add \$121 |
| Top-Down/Bottom-Up | Price as a standard shade, then add \$163 |
| Top-Down Only Shades | Price as a standard shade, then add \$163 |
| Day-Night Shades | Price each fabric as a separate shade and add together |
| Top-Down/Bottom-Up Cordless | Add \$193 to the Standard Cordless Pricing |
| Top-Down/Bottom-Up Continuous Cord..... | Add \$204 to Standard Continuous Cord Pricing |
| Cut-Outs..... | \$89 per side (subject to approval)* |
| Lift & Lock Cordless | Free Upgrade |
| Standard Cordless | \$165 |
| Top-Down/Bottom-Up Lift & Lock Cordless..... | Add \$165 |

*There are no limits on cut-out heights. There are, however limits on cut-out widths. Less than 18" shade means 3" max width cut-out. More than 18" shade means 5" max width cut-out

**Standard Continuous Cord for Top-Down/Bottom-Up add \$124 to Standard Continuous Cord System surcharge

Prices subject to change without notice

LONGITUDE SPECIFICATIONS

LONGITUDE

Longitude vertical honeycomb shades fit windows, sliding glass doors, and door openings. They open and close from side-to-side and are suited perfectly for sliding glass doors and room dividers. There are no dangling cords, hanging chains or wands making them a safer choice for children and pets.

Available in ¾" Single Cell Blackout, ¾" Single Cell Translucent, and ¾" Single Cell Sheer fabrics.



STACKING CONFIGURATIONS

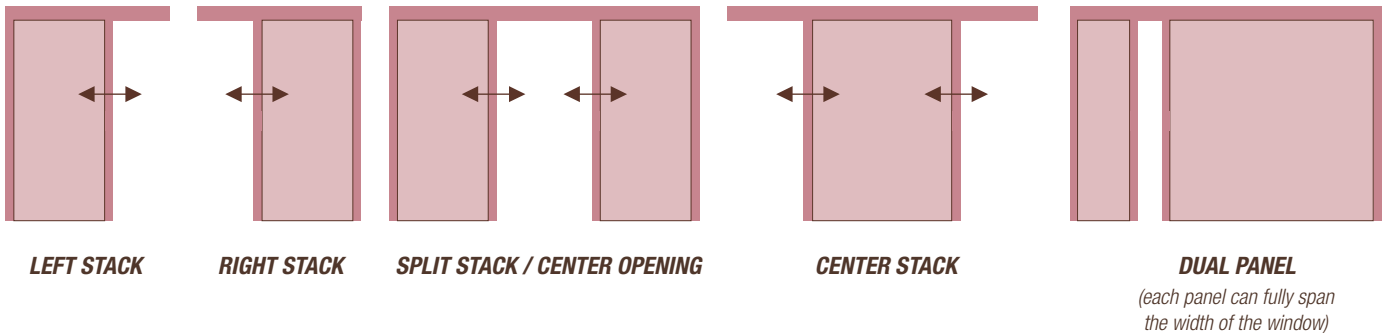

SIZE SPECIFICATIONS

- Minimum Width: 24"
- Minimum Height: 12"
- Maximum Width One Way Draw: 168"
- Maximum Height: 120"
- Maximum Width Split Draw/Center Opening*: 336"
- Maximum Height: 120"

*If width is greater than 185", it will be fabricated as two shades.

MOUNTING REQUIREMENTS

INSIDE MOUNT

- Minimum mounting depth required is 1 ¼"

May extend front of window

FLUSH MOUNT

- Minimum mounting depth required for:
 - Aluminum Valance is 3 5/8"
 - Alternative Wood Valance is 4"

OUTSIDE MOUNT

- Minimum flat vertical surface required is 1 1/8"

FABRIC STACKING

- 6 ½" (Fabric stack is determined by hardware, not ordered width)

FINISHED DIMENSIONS

INSIDE MOUNT

- Track rail will measure ordered width less 3/16"
- Shade height will measure ordered height less ½"
- Valance width (non-flush) will measure ordered width plus 1 ¼"
- Valance width (flush) will measure ordered width less 3/16"

OUTSIDE MOUNT

- Track rail will measure ordered width less 3/16"
- Shade height will measure ordered height
- Valance width (non-flush) will measure ordered width plus 1-¼"

Width and height measurements may vary +/- 1/8"

Please refer to price grids for surcharge information.

LONGITUDE SPECIFICATIONS

NO CHARGE OPTIONS

- Extension brackets
- Spacer blocks

Please note any options required at time of order.

VALANCE INFORMATION

An aluminum valance comes standard with your Longitude vertical honeycomb shade order. An alternative wood valance is also available at no extra charge. Please specify valance type on your order.

- Aluminum Valance Height: 17/8"
- Max Aluminum Valance Width: 190"

HARDWARE INFORMATION

- The track rail and fabric rails are available in soft white only
- The aluminum and alternative wood valances coordinate with the track rail



ALUMINUM VALANCE

ORDERING CHECKLIST

- Specify inside flush, inside non-flush, or outside mount. If inside non-flush mount, either the inside mounting depth or the exact valance return length (minimum 1 1/2") must be specified
- With outside mounts, allow 3" to 6" overlap on each side to minimize light gap, and account for minimum vertical mounting surface and desired floor clearance when specifying height
- Specify stacking configuration
- On split stack shades, both panels will be of equal width, unless otherwise specified
- On dual panel shades, specify which fabric stacks to the left and which fabric stacks to the right
- Standard handle height ranges from 40" to 50" from bottom of moving rail; specify any non-standard handle height
- An aluminum or alternative wood valance is included in the price of each shade. If no valance is specified, an aluminum valance will be supplied*
- Specify spacer blocks or extension brackets, if desired

**Alternative wood valances wider than 96" may be spliced in the center.*

LONGITUDE PRICE CHART 1-2

PRICE CHART L1 LONGITUDE - SIDE STACK

D-07 • 3/4" SINGLE CELL BLACKOUT, F-16, F-56 • 3/4" SINGLE CELL TRANSLUCENT, F-26 • 3/4" SINGLE CELL TEXTURED TRANSLUCENT, T-21 • 3/4" SINGLE CELL BI-LAM BLACKOUT, T-21L • 3/4" SINGLE CELL BI-LAM BLACKOUT LINEN

| | ← Width → | | | | | | | | | | | | | | | | | |
|------|-----------|------|------|------|------|------|------|------|------|------|------|------|------|------|------|------|------|------|
| | 24" | 30" | 36" | 42" | 48" | 54" | 60" | 66" | 72" | 78" | 84" | 96" | 108" | 120" | 132" | 144" | 156" | 168" |
| 36" | 790 | 868 | 965 | 1050 | 1125 | 1199 | 1279 | 1362 | 1444 | 1525 | 1599 | 1742 | 1898 | 2040 | 2177 | 2309 | 2457 | 2593 |
| 42" | 857 | 950 | 1052 | 1151 | 1241 | 1326 | 1421 | 1506 | 1609 | 1691 | 1779 | 1939 | 2119 | 2277 | 2440 | 2589 | 2755 | 2912 |
| 48" | 927 | 1029 | 1146 | 1249 | 1345 | 1448 | 1548 | 1658 | 1756 | 1858 | 1957 | 2136 | 2335 | 2517 | 2695 | 2867 | 3039 | 3206 |
| 54" | 989 | 1109 | 1235 | 1351 | 1460 | 1567 | 1678 | 1801 | 1913 | 2031 | 2132 | 2335 | 2550 | 2755 | 2958 | 3151 | 3319 | 3497 |
| 60" | 1056 | 1183 | 1322 | 1451 | 1572 | 1693 | 1818 | 1943 | 2066 | 2202 | 2313 | 2534 | 2767 | 2994 | 3212 | 3424 | 3619 | 3800 |
| 66" | 1127 | 1264 | 1419 | 1560 | 1686 | 1821 | 1952 | 2094 | 2225 | 2368 | 2491 | 2736 | 2994 | 3228 | 3473 | 3703 | 3922 | 4103 |
| 72" | 1195 | 1339 | 1505 | 1665 | 1798 | 1942 | 2087 | 2241 | 2382 | 2539 | 2678 | 2935 | 3212 | 3463 | 3733 | 3977 | 4204 | 4394 |
| 78" | 1264 | 1416 | 1597 | 1770 | 1913 | 2071 | 2231 | 2389 | 2539 | 2713 | 2855 | 3134 | 3434 | 3695 | 3992 | 4256 | 4484 | 4685 |
| 84" | 1331 | 1491 | 1686 | 1867 | 2020 | 2183 | 2362 | 2535 | 2713 | 2880 | 3036 | 3335 | 3657 | 3940 | 4250 | 4530 | 4762 | 4974 |
| 90" | 1394 | 1567 | 1774 | 1974 | 2139 | 2312 | 2502 | 2682 | 2857 | 3052 | 3210 | 3533 | 3869 | 4172 | 4503 | 4804 | 5042 | 5267 |
| 96" | 1463 | 1641 | 1863 | 2072 | 2255 | 2440 | 2627 | 2831 | 3017 | 3225 | 3386 | 3733 | 4079 | 4408 | 4760 | 5081 | 5324 | 5570 |
| 102" | 1525 | 1716 | 1947 | 2170 | 2362 | 2557 | 2755 | 2972 | 3170 | 3385 | 3557 | 3924 | 4293 | 4638 | 5009 | 5349 | 5602 | 5872 |
| 108" | 1588 | 1790 | 2029 | 2264 | 2470 | 2673 | 2888 | 3111 | 3319 | 3548 | 3727 | 4120 | 4503 | 4866 | 5255 | 5617 | 5892 | 6162 |
| 114" | 1652 | 1864 | 2114 | 2362 | 2578 | 2796 | 3017 | 3251 | 3471 | 3716 | 3900 | 4311 | 4715 | 5097 | 5508 | 5892 | 6173 | 6464 |
| 120" | 1713 | 1934 | 2198 | 2457 | 2682 | 2912 | 3142 | 3392 | 3624 | 3872 | 4074 | 4504 | 4927 | 5333 | 5757 | 6156 | 6451 | 6753 |

Refer to the Shade Size Specifications chart on page 7 for any size limitations or exclusions by fabric or operating system

PRICE CHART L2 LONGITUDE - SIDE STACK

D-13, D-14, D-15 • 3/4" SINGLE CELL TRANSLUCENT, D-16 • 3/4" SINGLE CELL FLAME RETARDANT BLACKOUT, F-17 • 3/4" SINGLE CELL BLACKOUT, F-27 • 3/4" SINGLE CELL TEXTURED BLACKOUT, F-36 • 3/4" SINGLE CELL TRANSLUCENT

| | ← Width → | | | | | | | | | | | | | | | | | |
|------|-----------|------|------|------|------|------|------|------|------|------|------|------|------|------|------|------|------|------|
| | 24" | 30" | 36" | 42" | 48" | 54" | 60" | 66" | 72" | 78" | 84" | 96" | 108" | 120" | 132" | 144" | 156" | 168" |
| 36" | 879 | 955 | 1040 | 1118 | 1187 | 1264 | 1345 | 1417 | 1496 | 1576 | 1644 | 1784 | 1920 | 2066 | 2197 | 2343 | 2478 | 2605 |
| 42" | 940 | 1028 | 1121 | 1209 | 1287 | 1374 | 1466 | 1548 | 1637 | 1725 | 1802 | 1963 | 2117 | 2286 | 2434 | 2601 | 2750 | 2901 |
| 48" | 999 | 1094 | 1202 | 1297 | 1385 | 1481 | 1581 | 1686 | 1781 | 1870 | 1966 | 2149 | 2316 | 2502 | 2666 | 2855 | 3028 | 3190 |
| 54" | 1055 | 1166 | 1279 | 1388 | 1483 | 1589 | 1698 | 1812 | 1920 | 2021 | 2127 | 2326 | 2516 | 2720 | 2913 | 3110 | 3294 | 3481 |
| 60" | 1115 | 1234 | 1358 | 1478 | 282 | 1701 | 1820 | 1941 | 2054 | 2173 | 2283 | 2504 | 2712 | 2940 | 3146 | 3370 | 3574 | 3771 |
| 66" | 1179 | 1305 | 1439 | 1570 | 1686 | 1810 | 1933 | 2079 | 2195 | 2326 | 2433 | 2687 | 2912 | 3151 | 3379 | 3619 | 3841 | 4061 |
| 72" | 1245 | 1381 | 1521 | 1663 | 1796 | 1922 | 2052 | 2206 | 2336 | 2473 | 2595 | 2878 | 3110 | 3379 | 3617 | 3879 | 4117 | 4348 |
| 78" | 1308 | 1450 | 1604 | 1759 | 1897 | 2041 | 2181 | 2341 | 2480 | 2625 | 2752 | 3050 | 3303 | 3589 | 3854 | 4132 | 4386 | 4640 |
| 84" | 1374 | 1526 | 1682 | 1853 | 2005 | 2149 | 2302 | 2471 | 2625 | 2778 | 2913 | 3231 | 3502 | 3804 | 4085 | 4384 | 4662 | 4927 |
| 90" | 1433 | 1598 | 1773 | 1954 | 2105 | 2264 | 2427 | 2613 | 2770 | 2932 | 3083 | 3413 | 3698 | 4032 | 4331 | 4638 | 4924 | 5216 |
| 96" | 1494 | 1667 | 1856 | 2044 | 2204 | 2371 | 2556 | 2742 | 2913 | 3088 | 3242 | 3600 | 3899 | 4246 | 4568 | 4892 | 5198 | 5498 |
| 102" | 1557 | 1736 | 1933 | 2129 | 2298 | 2478 | 2666 | 2863 | 3047 | 3231 | 3388 | 3764 | 4087 | 4451 | 4788 | 5126 | 5450 | 5770 |
| 108" | 1617 | 1810 | 2011 | 2214 | 2394 | 2579 | 2780 | 2986 | 3182 | 3370 | 3539 | 3932 | 4271 | 4648 | 5011 | 5363 | 5711 | 6039 |
| 114" | 1680 | 1883 | 2087 | 2304 | 2488 | 2684 | 2897 | 3110 | 3317 | 3517 | 3689 | 4105 | 4454 | 4853 | 5230 | 5599 | 5959 | 6311 |
| 120" | 1740 | 1947 | 2163 | 2386 | 2581 | 2786 | 3009 | 3231 | 3443 | 3650 | 3838 | 4271 | 4635 | 5051 | 5448 | 5837 | 6214 | 6583 |

Refer to the Shade Size Specifications chart on page 7 for any size limitations or exclusions by fabric or operating system

DESIGN OPTION SURCHARGES

- Center Stack..... Add \$207 to shade base price
- Split Stack/Center Opening.....Divide full width measurement in half, price as two separate units, add together
- Dual Panel Price as two separate units and add together

Prices subject to change without notice

LONGITUDE PRICE CHART 3-4

PRICE CHART L3 LONGITUDE - SIDE STACK

D-06 • 3/4" SINGLE CELL SEMI SHEER, D-08, D-09 • 3/4" SINGLE CELL KNITTED SHEER, F-37 • 3/4" SINGLE CELL BLACKOUT, G-23, G-24, G-25 • 3/4" SINGLE CELL BLACKOUT

| | ← Width → | | | | | | | | | | | | | | | | | |
|------|-----------|------|------|------|------|------|------|------|------|------|------|------|------|------|------|------|------|------|
| | 24" | 30" | 36" | 42" | 48" | 54" | 60" | 66" | 72" | 78" | 84" | 96" | 108" | 120" | 132" | 144" | 156" | 168" |
| 36" | 1149 | 1248 | 1360 | 1462 | 1550 | 1652 | 1758 | 1852 | 1956 | 2060 | 2152 | 2332 | 2508 | 2701 | 2874 | 3066 | 3239 | 3408 |
| 42" | 1226 | 1341 | 1465 | 1580 | 1680 | 1797 | 1917 | 2026 | 2140 | 2255 | 2358 | 2566 | 2767 | 2990 | 3185 | 3402 | 3596 | 3790 |
| 48" | 1305 | 1427 | 1568 | 1696 | 1812 | 1939 | 2070 | 2205 | 2328 | 2444 | 2570 | 2809 | 3031 | 3271 | 3487 | 3733 | 3956 | 4172 |
| 54" | 1379 | 1526 | 1671 | 1817 | 1941 | 2079 | 2220 | 2368 | 2508 | 2643 | 2779 | 3040 | 3289 | 3557 | 3810 | 4068 | 4308 | 4550 |
| 60" | 1457 | 1613 | 1776 | 1932 | 2070 | 2225 | 2379 | 2537 | 2686 | 2840 | 2986 | 3276 | 3546 | 3841 | 4114 | 4407 | 4673 | 4930 |
| 66" | 1540 | 1705 | 1880 | 2054 | 2205 | 2364 | 2527 | 2717 | 2869 | 3040 | 3182 | 3513 | 3804 | 4120 | 4416 | 4734 | 5023 | 5309 |
| 72" | 1626 | 1804 | 1989 | 2173 | 2347 | 2512 | 2681 | 2882 | 3055 | 3234 | 3394 | 3761 | 4068 | 4416 | 4732 | 5074 | 5383 | 5684 |
| 78" | 1710 | 1898 | 2097 | 2301 | 2480 | 2666 | 2848 | 3062 | 3242 | 3434 | 3601 | 3987 | 4320 | 4695 | 5038 | 5403 | 5735 | 6068 |
| 84" | 1797 | 1996 | 2203 | 2422 | 2621 | 2809 | 3009 | 3232 | 3434 | 3633 | 3810 | 4226 | 4580 | 4976 | 5338 | 5733 | 6096 | 6444 |
| 90" | 1874 | 2089 | 2318 | 2550 | 2750 | 2962 | 3174 | 3415 | 3623 | 3832 | 4031 | 4464 | 4835 | 5273 | 5662 | 6063 | 6440 | 6818 |
| 96" | 1954 | 2182 | 2426 | 2672 | 2880 | 3104 | 3341 | 3585 | 3810 | 4037 | 4241 | 4704 | 5099 | 5550 | 5972 | 6396 | 6798 | 7187 |
| 102" | 2037 | 2271 | 2527 | 2781 | 3005 | 3239 | 3487 | 3744 | 3981 | 4226 | 4431 | 4922 | 5342 | 5822 | 6263 | 6703 | 7127 | 7546 |
| 108" | 2116 | 2364 | 2627 | 2896 | 3132 | 3372 | 3636 | 3902 | 4161 | 4407 | 4625 | 5141 | 5584 | 6078 | 6552 | 7011 | 7468 | 7900 |
| 114" | 2197 | 2462 | 2731 | 3011 | 3254 | 3509 | 3787 | 4068 | 4336 | 4596 | 4824 | 5367 | 5825 | 6345 | 6837 | 7322 | 7791 | 8253 |
| 120" | 2274 | 2544 | 2825 | 3119 | 3376 | 3643 | 3932 | 4226 | 4503 | 4773 | 5019 | 5584 | 6060 | 6606 | 7122 | 7632 | 8128 | 8606 |

Refer to the Shade Size Specifications chart on page 7 for any size limitations or exclusions by fabric or operating system

PRICE CHART L4 LONGITUDE - SIDE STACK

G-03 • 3/4" SINGLE CELL WOVEN TRANSLUCENT, G-04 • 3/4" SINGLE CELL WOVEN BLACKOUT

| | ← Width → | | | | | | | | | | | | | | | | | |
|------|-----------|------|------|------|------|------|------|------|------|------|------|------|------|------|------|------|------|------|
| | 24" | 30" | 36" | 42" | 48" | 54" | 60" | 66" | 72" | 78" | 84" | 96" | 108" | 120" | 132" | 144" | 156" | 168" |
| 36" | 894 | 971 | 1059 | 1138 | 1207 | 1286 | 1369 | 1442 | 1523 | 1604 | 1676 | 1816 | 1953 | 2103 | 2238 | 2388 | 2522 | 2654 |
| 42" | 954 | 1044 | 1140 | 1230 | 1308 | 1399 | 1492 | 1577 | 1666 | 1756 | 1836 | 1998 | 2155 | 2329 | 2480 | 2649 | 2801 | 2952 |
| 48" | 1016 | 1111 | 1221 | 1320 | 1411 | 1509 | 1611 | 1717 | 1813 | 1903 | 2001 | 2187 | 2360 | 2547 | 2716 | 2907 | 3081 | 3249 |
| 54" | 1073 | 1188 | 1301 | 1414 | 1511 | 1619 | 1729 | 1844 | 1953 | 2058 | 2164 | 2367 | 2562 | 2770 | 2967 | 3168 | 3355 | 3544 |
| 60" | 1134 | 1256 | 1383 | 1504 | 1611 | 1732 | 1852 | 1976 | 2091 | 2211 | 2325 | 2551 | 2761 | 2991 | 3204 | 3432 | 3640 | 3839 |
| 66" | 1199 | 1328 | 1464 | 1599 | 1717 | 1841 | 1968 | 2116 | 2234 | 2367 | 2478 | 2736 | 2963 | 3209 | 3439 | 3687 | 3912 | 4135 |
| 72" | 1266 | 1405 | 1549 | 1692 | 1827 | 1956 | 2088 | 2245 | 2379 | 2519 | 2643 | 2929 | 3168 | 3439 | 3685 | 3952 | 4192 | 4427 |
| 78" | 1331 | 1478 | 1633 | 1791 | 1931 | 2076 | 2218 | 2384 | 2525 | 2674 | 2804 | 3105 | 3365 | 3657 | 3924 | 4208 | 4467 | 4726 |
| 84" | 1399 | 1554 | 1715 | 1886 | 2041 | 2187 | 2343 | 2517 | 2674 | 2829 | 2967 | 3291 | 3567 | 3875 | 4157 | 4465 | 4748 | 5019 |
| 90" | 1459 | 1627 | 1805 | 1986 | 2142 | 2306 | 2472 | 2659 | 2821 | 2984 | 3139 | 3477 | 3766 | 4107 | 4410 | 4722 | 5016 | 5311 |
| 96" | 1521 | 1699 | 1889 | 2081 | 2243 | 2417 | 2602 | 2792 | 2967 | 3144 | 3303 | 3664 | 3971 | 4323 | 4652 | 4982 | 5295 | 5598 |
| 102" | 1586 | 1768 | 1968 | 2166 | 2340 | 2522 | 2716 | 2916 | 3101 | 3291 | 3451 | 3833 | 4161 | 4534 | 4878 | 5221 | 5551 | 5878 |
| 108" | 1647 | 1841 | 2046 | 2255 | 2439 | 2626 | 2832 | 3039 | 3240 | 3432 | 3602 | 4004 | 4349 | 4734 | 5103 | 5461 | 5817 | 6153 |
| 114" | 1711 | 1917 | 2126 | 2345 | 2534 | 2733 | 2949 | 3168 | 3377 | 3580 | 3757 | 4180 | 4537 | 4942 | 5325 | 5703 | 6068 | 6428 |
| 120" | 1771 | 1981 | 2200 | 2429 | 2629 | 2837 | 3062 | 3291 | 3507 | 3718 | 3909 | 4349 | 4720 | 5145 | 5547 | 5945 | 6331 | 6703 |

Refer to the Shade Size Specifications chart on page 7 for any size limitations or exclusions by fabric or operating system

DESIGN OPTION SURCHARGES

- Center Stack..... Add \$207 to shade base price
- Split Stack/Center Opening.....Divide full width measurement in half, price as two separate units, add together
- Dual Panel Price as two separate units and add together

Prices subject to change without notice

CHILD SAFETY & WARRANTY

CHILD SAFETY

Every product we send out meets or exceeds the latest safety standards as set forth by the Consumer Product Safety Council and the Window Covering Manufacturers Association. For enhanced safety, Automated Motorized Shades offers cordless and motorized window treatments.

REMEMBER THESE SAFETY RULES...

- For children's bedrooms only install window coverings that are cordless.
- Any window coverings in your home that were made before 2001, should be replaced with today's newer, safer models.
- Do not place furniture near windows that have window coverings with cords.
- Keep all cords out of reach from small children. Do this by securing tasseled pull cords out of reach with a cord cleat, and anchoring continuous-loop cords to the wall with safety devices.
- Always be sure to lock and firmly secure cords in position.
- Products such as Roman or Woven Wood Shades that have accessible back cords, should not be installed within reach of children.

All products come with safety labels attached. This is to help raise awareness of the potential safety risks associated with the products you purchase. If you have any concerns, please do not hesitate to contact us directly. You may also directly contact any of the associations that create the safety standards with any questions or concerns. Child safety is our top priority!

WARRANTY

Automated Motorized Shades guarantees all products manufactured in our facility to be free from defects due to faulty workmanship and/or materials. We are so confident about our quality and dependability that we back our manual shades with a limited lifetime warranty, our motors with a 5 year limited warranty, and our custom printed shades with a 3 year warranty against fading. All warranties are effective from the original invoice date of the product.

This guarantee does not apply to damage to exterior shades caused by high winds and/or extreme weather conditions. Any roller shade or parts which fail due to abuse, accident, theft, alterations, improper use or

installation, or gradual color fading, are also excluded from this warranty.

Automated Motorized Shades reserves the right to inspect products and will replace or repair any product found to be defective as a result of faulty workmanship or materials.

Shipping charges, trip charges and labor costs for measuring and installation and/or removal of old or current products are excluded. This

warranty is available to the original owner/purchaser and is non-transferable. Automated Motorized Shades' warranty is designed to ensure a thoroughly satisfying experience with your window treatment product. Certain restrictions may apply.

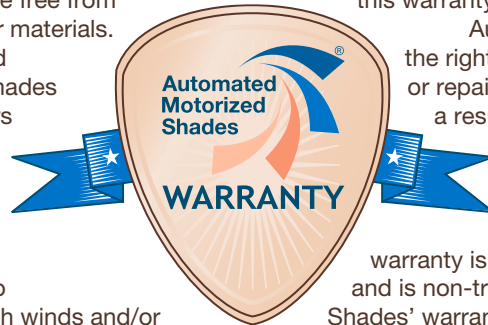



WOVEN WOOD COLLECTION
PRICING GUIDE

TABLE OF CONTENTS

| | |
|--|----|
| Basic Guidelines..... | 1 |
| Measuring Guidelines..... | 2 |
| Hardware Options..... | 3 |
| Liner Options..... | 4 |
| Gallery Collection Patterns..... | 5 |
| Woven Wood Price Charts..... | 6 |
| Price Chart 1..... | 6 |
| Price Chart 2..... | 6 |
| Price Chart 3..... | 7 |
| Price Chart 4..... | 7 |
| Price Chart 5..... | 8 |
| Liner Price Charts..... | 9 |
| Price Chart 1..... | 9 |
| Price Chart 2..... | 9 |
| Dual Shade Price Charts..... | 10 |
| Price Chart 1..... | 10 |
| Price Chart 2..... | 10 |
| Edge Banding Options..... | 11 |
| Available Styles..... | 11 |
| ½ Twill Edge Binding Price Chart..... | 11 |
| 1 ½ Twill Edge Binding Price Chart..... | 11 |
| Additional Information And Specifications..... | 12 |
| Stacking Chart & Minimum Depth Requirements..... | 12 |
| Child Safety & Warranty..... | 13 |

BASIC GUIDELINES

- Woven Wood shades are fashioned from natural reeds, fibers and bamboo to help create both formal and informal settings for any room in the home.
- Multiple patterns offer distinctive textures, grains, colors, and styles that can change the mood of any room to exotic, casual, formal, or rustic.
- Reeds are woven together, retaining their natural textures and colors, offering a handcrafted look while still adding character and charm to the ambiance of any room.
- These stylish affordable shades can be manufactured with a simple pulley system, a continuous loop chain, or cordless lifting system.
- Numerous options including lining and duo shade systems are available to truly customize Woven Wood shades to suit any décor or scenario.
- AMS Signature Woven Wood shades are covered by a 1 year fabric warranty and a 3 year mechanism warranty.
- Box Surcharge – Shades 93” or wider (up to 3 shades per box) \$340.00 NET surcharge.
- Peak Season Surcharge will be charged as per FedEx or UPS at net cost (up to 10% of total order).

MEASURING GUIDELINES

MEASUREMENTS

Accurate measurements are essential for correct pricing and proper fit. Use only a hard-edged ruler or steel tape, never a cloth tape. For *inside mounts*, width measurements (A) should be rounded *down* to the nearest 1/8" to prevent blind from rubbing against the window casing.

BASIC GUIDELINES

Use a steel tape to measure the opening width (A) at three different places, and use the narrowest dimension when ordering. Be exact! The factory will make the shade 1/2" narrower so it will not rub against the window casing. Measure the height (B) of the window from the top (Soffit) down to the sill.

OUTSIDE MOUNT

Use a steel tape to measure the exact width (C) and height (D) of the area to be covered. It is recommended that the shades overlap the window by at least 1 1/2" on each side. When installation has no sill, allow the shade to overlap the bottom of the window casing by at least 1 1/2". Shade fabric will measure the exact width indicated on the order form.

FINISHED DIMENSIONS

INSIDE (IB) MOUNT

Headrail Unit and Fabric Width -1/2"
Shade Height..... Ordered Height

OUTSIDE (OB) MOUNT

Headrail Unit and Fabric WidthOrdered Width
Shade Height..... Ordered Height

HEADRAIL INFORMATION

CLASSIC, 2 ON 1, AND TOP DOWN/BOTTOM UP SHADES

Mounted on a 1" x 1 1/2" Headrail

CLUTCH OPERATED

Mounted on a 1" x 2 1/2" Headrail

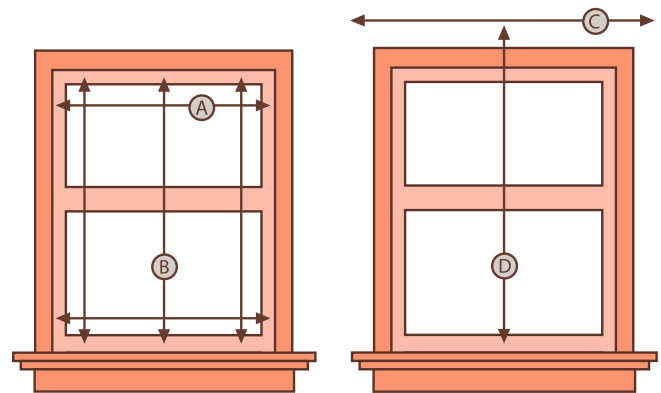

INSIDE MOUNT

OUTSIDE MOUNT

MOUNTING INFORMATION

INSIDE (IB) MOUNT

Minimum Mounting Depth..... Classic (Cordlock) Headrail 1 1/2"
Clutch Headrail 2 1/2"

OUTSIDE (OB) MOUNT

Minimum Mounting Depth..... 1" flat vertical surface

MOUNTING BRACKETS INCLUDED

| Shade Width | # of Brackets Included |
|------------------|------------------------|
| 18" - 40" | 2 |
| 52" - 96" | 3 |
| 96" - 144" | 4 |

STACKING HEIGHTS

| Shade Length | Approximate Stacking Height |
|--------------------|-----------------------------|
| Up to 72" | 7" |
| 72" to 84" | 8" |
| 84" to 96" | 9" |
| 96" to 108" | 10" |
| 108" to 120" | 11" |

HARDWARE OPTIONS

OVERVIEW

Woven Wood shades are created from natural products such as reeds, bamboo, grasses, and wood, that will age beautifully over time. It is possible that some patterns may grow slightly lighter or darker in color, depending on the fabric pattern. Variations in paint and stain, minor cracks, slight pattern irregularities and knots are all enhancements that add to the natural beauty and character of your shade. Standard Shade valance height is 7"

Cord Lock control is standard. Please specify control position. Clutch or Cordless options are available - Cordless Max. size 78" x 72"

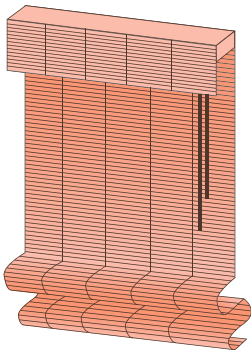

CLASSIC ROMAN

Hangs flat when lowered and self valance is standard off front of Classic Roman Shades to neatly conceal shades hardware. Operated with a cord lock. Must specify cord lock position right or left. Cord lock right side is standard.

2-ON-1 OR 3-ON-1 HEADRAIL

Perfect for large windows, this style allows you to have two shades on the same headrail for independent control and more practicality. Price as separate shades and add together.

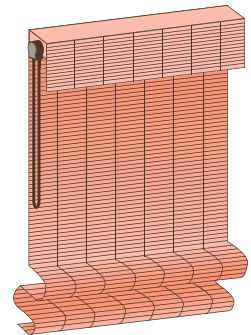
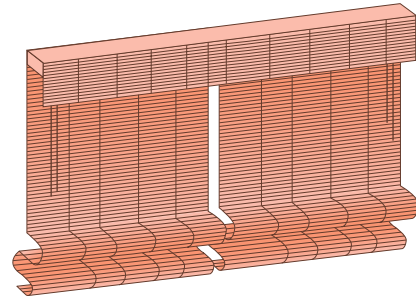

ROMAN WITH CLUTCH

Looks just like the Classic Roman, but has a continuous chain clutch mechanism for easier control and enhanced safety. Shaftwind system is a clutch system operated by a spear retainer and does not operate on a roller tube.

Note: Skyline system operates with a roller tube, standard on romans under 22" wide and large shades. Please specify system.

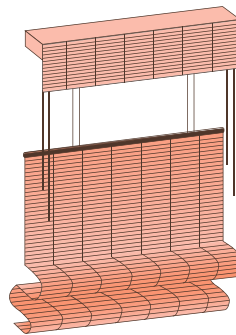

TOP-DOWN / BOTTOM-UP

Versatile, this style is perfect for those places where privacy is needed while still preserving a clear view to the outside and allowing natural light into the room.

LINER OPTIONS

See Available Liner Colors in the Gallery Sample Book

OVERVIEW

The materials to make Woven Wood shades have unique variations in both color and texture. The size and shape of the slats, reeds and grasses will affect spacing from shade to shade. This variation is normal and does not represent a defect in the material. Woven Wood shades alone will filter rather than block light. Some of the woven wood patterns will provide daylight privacy; however, for added night privacy, a liner upgrade is recommended.

If a liner is chosen, you must specify your liner option on your order (please refer to price grids for pricing information). Black or beige liner colors are great to coordinate with darker colored Woven Wood Shades, while white and ivory are perfect for lighter colors.

STANDARD VS OPERABLE

A standard Woven Wood shade liner is a fixed liner upgrade for consistent filtering or blocking of light. The liner will move with your Woven Wood shade but cannot be moved as a separate unit. An Operable Liner option is also available. This liner can be moved as a separate unit, which allows for more freedom in your light-filtering options.

HOW TO SPECIFY YOUR LINER

1. Choose your opacity: Light Filtering or Room Darkening.
2. Choose your color option from those shown below: (This is the color that will be seen slightly through the fabric spacing).



NO LINER



WITH LINER



OPERABLE LINER

GALLERY COLLECTION PATTERNS

| Pattern Name | Price Chart | Fabric Width |
|--------------|-------------|--------------|
| Amour | 5 | 96" |
| Argos | 1 | 96" |
| Aris | 2 | 96" |
| Avedon | 4 | 96" |
| Avia | 2 | 96" |
| Bamboo | 2 | 96" |
| Barents * | 5 | 96" |
| Bedford | 2 | 96" |
| Bengali * | 5 | 96" |
| Boras | 5 | 96" |
| Bromley | 1 | 96" |
| Clayton | 2 | 96" |
| Coral | 3 | 96" |
| Edessa * | 2 | 96" |
| Goya * | 5 | 96" |
| Isamu * | 3 | 96" |
| Kara * | 1 | 96" |
| Kyoto | 2 | 96" |
| Lulea | 4 | 96" |
| Mesabi | 2 | 96" |
| Mogu | 4 | 96" |
| Norfolk | 2 | 96" |
| Odene | 3 | 96" |
| Osaka | 2 | 96" |
| Serenity | 5 | 96" |
| Srilanka | 5 | 96" |
| Vaasa | 5 | 96" |
| Warwick | 1 | 96" |
| Zagoli | 1 | 96" |

Minimum width 12", recommended minimum height is 24"

***DENOTES THAT PATTERN HAS DISCONTINUED COLORS (SEE BELOW)**

- Barents Cornsilk - Discontinued
- Bengali Grass - Discontinued
- Edessa Latte - Discontinued
- Goya Earth - Discontinued
- Isamu White - Discontinued
- Kara Wheat - Discontinued
- Kara Slate - Discontinued

PRICE CHARTS 1-2

(Hobbled Shades Add 30% to Shade Price)

PRICE CHART 1

← Width →

| | 24" | 30" | 36" | 42" | 48" | 60" | 72" | 84" | 96" |
|--------|-----|-----|-----|-----|-----|-----|-----|------|------|
| 36" | 201 | 233 | 264 | 299 | 338 | 412 | 524 | 604 | 771 |
| 42" | 205 | 238 | 270 | 305 | 345 | 423 | 538 | 618 | 788 |
| 48" | 208 | 243 | 277 | 312 | 353 | 432 | 550 | 634 | 805 |
| 54" | 233 | 272 | 311 | 351 | 401 | 488 | 616 | 710 | 891 |
| 60" | 238 | 279 | 318 | 360 | 408 | 498 | 628 | 724 | 908 |
| 66" | 245 | 287 | 327 | 372 | 416 | 510 | 640 | 739 | 923 |
| 72" | 265 | 312 | 359 | 407 | 456 | 559 | 700 | 809 | 1004 |
| 78" | 269 | 319 | 364 | 414 | 464 | 570 | 713 | 824 | 1021 |
| 84" | 273 | 323 | 369 | 422 | 473 | 580 | 725 | 837 | 1037 |
| 90" | 299 | 353 | 406 | 461 | 518 | 636 | 791 | 914 | 1124 |
| 96" | 303 | 359 | 412 | 469 | 525 | 646 | 804 | 929 | 1141 |
| 102" | 306 | 364 | 417 | 476 | 535 | 656 | 815 | 943 | 1158 |
| 108" | 327 | 388 | 448 | 512 | 576 | 706 | 876 | 1013 | 1237 |
| 114" | 330 | 394 | 454 | 519 | 583 | 717 | 889 | 1027 | 1253 |
| 120" | 336 | 399 | 460 | 525 | 592 | 727 | 901 | 1042 | 1270 |
| Add 6" | 6 | 7 | 8 | 8 | 9 | 11 | 13 | 14 | 16 |

Longer sizes are available with some limitations, contact customer service for pricing and information

PRICE CHART 2

← Width →

| | 24" | 30" | 36" | 42" | 48" | 60" | 72" | 84" | 96" |
|--------|-----|-----|-----|-----|-----|-----|-----|------|------|
| 36" | 212 | 248 | 281 | 319 | 359 | 437 | 557 | 642 | 813 |
| 42" | 218 | 254 | 289 | 327 | 369 | 452 | 573 | 660 | 835 |
| 48" | 223 | 261 | 298 | 338 | 381 | 466 | 590 | 679 | 856 |
| 54" | 249 | 292 | 335 | 381 | 428 | 523 | 659 | 761 | 949 |
| 60" | 256 | 300 | 343 | 389 | 439 | 538 | 676 | 780 | 971 |
| 66" | 262 | 308 | 353 | 403 | 451 | 552 | 692 | 800 | 993 |
| 72" | 283 | 336 | 386 | 439 | 494 | 606 | 756 | 874 | 1079 |
| 78" | 289 | 343 | 394 | 449 | 503 | 620 | 772 | 893 | 1101 |
| 84" | 296 | 349 | 403 | 458 | 516 | 633 | 789 | 913 | 1123 |
| 90" | 321 | 382 | 439 | 501 | 563 | 692 | 859 | 993 | 1216 |
| 96" | 326 | 388 | 448 | 512 | 574 | 706 | 875 | 1013 | 1237 |
| 102" | 331 | 395 | 456 | 520 | 585 | 720 | 892 | 1032 | 1259 |
| 108" | 353 | 423 | 488 | 559 | 628 | 774 | 958 | 1108 | 1344 |
| 114" | 360 | 429 | 496 | 569 | 639 | 787 | 974 | 1127 | 1367 |
| 120" | 365 | 436 | 504 | 578 | 650 | 802 | 990 | 1145 | 1389 |
| Add 6" | 7 | 8 | 9 | 10 | 12 | 14 | 16 | 18 | 21 |

Longer sizes are available with some limitations, contact customer service for pricing and information

LIFT SYSTEM SURCHARGES

| CLUTCH | 24" | 36" | 48" | 60" | 72" | 84" | 96" |
|--------|-----|-----|-----|-----|-----|-----|-----|
| 120" | 138 | 149 | 167 | 185 | 199 | 226 | 237 |

Note: Minimum Clutch is 13"

| CORDLESS | 36" | 48" | 60" | 72" | 84" | 96" |
|----------|-----|-----|-----|-----|-----|-----|
| 36" | 131 | 150 | 208 | 242 | 267 | 275 |

Note: Minimum Cordless is 24"

ADDITIONAL CHARGES

| | | | |
|--|---|----------------------------|--------------------------|
| Top-Down/Bottom-Up (84" max width) | \$184 per shade | Cut-Outs..... | \$120 |
| Oversized Board>Returns | \$99 | Returns & Hold Downs | Free - Must be requested |
| 2-on-1 or 3-on-1 (144" max width)..... | Price as separate shades & add together | | |

Prices subject to change without notice

PRICE CHARTS 3-4

(Hobbled Shades Add 30% to Shade Price)

PRICE CHART 3

| | | ← Width → | | | | | | | | |
|----------|--------|-----------|-----|-----|-----|-----|-----|------|------|------|
| | | 24" | 30" | 36" | 42" | 48" | 60" | 72" | 84" | 96" |
| Height ↑ | 36" | 238 | 276 | 312 | 363 | 406 | 498 | 627 | 724 | 909 |
| | 42" | 246 | 285 | 325 | 378 | 424 | 519 | 654 | 754 | 943 |
| | 48" | 256 | 297 | 339 | 393 | 440 | 541 | 679 | 785 | 979 |
| | 54" | 289 | 338 | 386 | 438 | 492 | 603 | 753 | 870 | 1074 |
| | 60" | 299 | 348 | 399 | 454 | 510 | 626 | 779 | 900 | 1108 |
| | 66" | 306 | 360 | 412 | 469 | 525 | 647 | 806 | 931 | 1143 |
| | 72" | 328 | 387 | 445 | 507 | 570 | 702 | 871 | 1007 | 1231 |
| | 78" | 339 | 397 | 458 | 522 | 587 | 724 | 896 | 1039 | 1266 |
| | 84" | 346 | 408 | 472 | 538 | 604 | 746 | 923 | 1068 | 1300 |
| | 90" | 374 | 444 | 512 | 583 | 656 | 808 | 997 | 1153 | 1397 |
| | 96" | 384 | 454 | 523 | 599 | 674 | 830 | 1023 | 1184 | 1432 |
| | 102" | 392 | 464 | 537 | 614 | 691 | 851 | 1048 | 1215 | 1467 |
| | 108" | 414 | 493 | 570 | 653 | 734 | 907 | 1116 | 1292 | 1554 |
| | 114" | 424 | 502 | 583 | 668 | 752 | 929 | 1141 | 1321 | 1590 |
| | 120" | 432 | 515 | 596 | 682 | 769 | 951 | 1166 | 1353 | 1625 |
| | Add 6" | 10 | 12 | 13 | 15 | 17 | 21 | 26 | 30 | 34 |

Longer sizes are available with some limitations, contact customer service for pricing and information

PRICE CHART 4

| | | ← Width → | | | | | | | | |
|----------|--------|-----------|-----|-----|-----|-----|------|------|------|------|
| | | 24" | 30" | 36" | 42" | 48" | 60" | 72" | 84" | 96" |
| Height ↑ | 36" | 258 | 299 | 340 | 386 | 432 | 529 | 666 | 767 | 959 |
| | 42" | 269 | 314 | 357 | 407 | 456 | 559 | 701 | 810 | 1006 |
| | 48" | 282 | 328 | 375 | 429 | 479 | 590 | 738 | 852 | 1056 |
| | 54" | 307 | 361 | 412 | 471 | 525 | 647 | 805 | 929 | 1142 |
| | 60" | 320 | 375 | 431 | 492 | 551 | 677 | 842 | 971 | 1190 |
| | 66" | 331 | 390 | 448 | 513 | 576 | 706 | 876 | 1013 | 1239 |
| | 72" | 351 | 414 | 477 | 548 | 614 | 755 | 935 | 1081 | 1317 |
| | 78" | 364 | 429 | 496 | 569 | 638 | 786 | 971 | 1123 | 1365 |
| | 84" | 375 | 445 | 514 | 590 | 661 | 815 | 1007 | 1166 | 1414 |
| | 90" | 403 | 476 | 550 | 632 | 709 | 872 | 1075 | 1243 | 1500 |
| | 96" | 414 | 492 | 569 | 653 | 733 | 902 | 1110 | 1285 | 1549 |
| | 102" | 427 | 506 | 585 | 674 | 758 | 933 | 1146 | 1329 | 1596 |
| | 108" | 446 | 532 | 615 | 708 | 796 | 982 | 1205 | 1396 | 1674 |
| | 114" | 458 | 545 | 634 | 728 | 822 | 1012 | 1242 | 1438 | 1724 |
| | 120" | 471 | 561 | 651 | 749 | 845 | 1043 | 1277 | 1481 | 1772 |
| | Add 6" | 12 | 15 | 18 | 20 | 25 | 30 | 35 | 40 | 47 |

Longer sizes are available with some limitations, contact customer service for pricing and information

LIFT SYSTEM SURCHARGES

| CLUTCH | 24" | 36" | 48" | 60" | 72" | 84" | 96" |
|--------|-----|-----|-----|-----|-----|-----|-----|
| 120" | 138 | 149 | 167 | 185 | 199 | 226 | 237 |

Note: Minimum Clutch is 13"

| CORDLESS | 36" | 48" | 60" | 72" | 84" | 96" |
|----------|-----|-----|-----|-----|-----|-----|
| 36" | 131 | 150 | 208 | 242 | 267 | 275 |

Note: Minimum Cordless is 24"

ADDITIONAL CHARGES

| | | | |
|--|---|----------------------------|--------------------------|
| Top-Down/Bottom-Up (84" max width) | \$184 per shade | Cut-Outs..... | \$120 |
| Oversized Board/Returns | \$99 | Returns & Hold Downs | Free - Must be requested |
| 2-on-1 or 3-on-1 (144" max width)..... | Price as separate shades & add together | | |

Prices subject to change without notice

PRICE CHART 5

(Hobbled Shades Add 30% to Shade Price)

PRICE CHART 5

| | | ← Width → | | | | | | | | |
|----------|------|-----------|-----|-----|-----|-----|------|------|------|------|
| | | 24" | 30" | 36" | 42" | 48" | 60" | 72" | 84" | 96" |
| Height ↑ | 36" | 281 | 327 | 374 | 427 | 477 | 585 | 733 | 846 | 1047 |
| | 42" | 296 | 345 | 395 | 453 | 506 | 622 | 776 | 896 | 1106 |
| | 48" | 309 | 364 | 417 | 478 | 536 | 658 | 822 | 948 | 1165 |
| | 54" | 341 | 401 | 459 | 524 | 590 | 724 | 896 | 1036 | 1265 |
| | 60" | 355 | 417 | 480 | 551 | 618 | 760 | 941 | 1087 | 1322 |
| | 66" | 369 | 436 | 502 | 577 | 648 | 797 | 984 | 1139 | 1381 |
| | 72" | 392 | 464 | 537 | 616 | 692 | 853 | 1052 | 1218 | 1472 |
| | 78" | 407 | 482 | 559 | 642 | 721 | 890 | 1097 | 1270 | 1531 |
| | 84" | 422 | 501 | 581 | 668 | 752 | 927 | 1141 | 1319 | 1590 |
| | 90" | 452 | 537 | 622 | 714 | 805 | 991 | 1217 | 1409 | 1689 |
| | 96" | 466 | 556 | 644 | 740 | 833 | 1027 | 1260 | 1460 | 1748 |
| | 102" | 480 | 574 | 667 | 766 | 864 | 1065 | 1305 | 1510 | 1805 |
| | 108" | 502 | 602 | 700 | 806 | 909 | 1121 | 1373 | 1590 | 1897 |
| | 114" | 518 | 620 | 723 | 831 | 938 | 1159 | 1417 | 1642 | 1956 |
| | 120" | 533 | 638 | 745 | 856 | 966 | 1195 | 1460 | 1692 | 2014 |
| Add 6" | 15 | 18 | 21 | 26 | 29 | 35 | 42 | 50 | 56 | |

Longer sizes are available with some limitations, contact customer service for pricing and information

LIFT SYSTEM SURCHARGES

| CLUTCH | 24" | 36" | 48" | 60" | 72" | 84" | 96" |
|--------|-----|-----|-----|-----|-----|-----|-----|
| 120" | 138 | 149 | 167 | 185 | 199 | 226 | 237 |

Note: Minimum Clutch is 13"

| CORDLESS | 36" | 48" | 60" | 72" | 84" | 96" |
|----------|-----|-----|-----|-----|-----|-----|
| 36" | 131 | 150 | 208 | 242 | 267 | 275 |

Note: Minimum Cordless is 24"

ADDITIONAL CHARGES

| | | | |
|--|---|----------------------------|--------------------------|
| Top-Down/Bottom-Up (84" max width) | \$184 per shade | Cut-Outs..... | \$120 |
| Oversized Board>Returns | \$99 | Returns & Hold Downs | Free - Must be requested |
| 2-on-1 or 3-on-1 (144" max width)..... | Price as separate shades & add together | | |

Prices subject to change without notice

LINER PRICE CHARTS

(Add Liner Pricing to Price of Shade) and
(Hobbled Shades Add 30% to Shade Price)

LIGHT FILTERING

| | | <— Width —> | | | | | | | | |
|------------------|------|-------------|-----|-----|-----|-----|-----|-----|-----|-----|
| | | 24" | 30" | 36" | 42" | 48" | 60" | 72" | 84" | 96" |
| Height ↑ ↓ | 36" | 49 | 53 | 59 | 66 | 81 | 107 | 121 | 136 | 149 |
| | 42" | 52 | 57 | 65 | 71 | 89 | 116 | 132 | 147 | 164 |
| | 48" | 55 | 62 | 70 | 77 | 96 | 125 | 143 | 162 | 179 |
| | 54" | 57 | 66 | 74 | 82 | 104 | 135 | 154 | 174 | 193 |
| | 60" | 62 | 70 | 78 | 88 | 111 | 144 | 165 | 187 | 208 |
| | 66" | 66 | 74 | 83 | 94 | 118 | 153 | 176 | 201 | 223 |
| | 72" | 70 | 77 | 89 | 100 | 126 | 163 | 187 | 213 | 238 |
| | 78" | 92 | 105 | 118 | 131 | 179 | 225 | 258 | 290 | 323 |
| | 84" | 95 | 110 | 124 | 139 | 187 | 235 | 270 | 305 | 341 |
| | 90" | 100 | 115 | 130 | 145 | 195 | 247 | 284 | 322 | 359 |
| | 96" | 103 | 120 | 136 | 151 | 205 | 259 | 298 | 338 | 377 |
| | 102" | 107 | 124 | 142 | 159 | 214 | 270 | 311 | 353 | 395 |
| | 108" | 110 | 129 | 146 | 164 | 224 | 281 | 325 | 369 | 413 |
| 114" | 115 | 133 | 152 | 171 | 233 | 292 | 340 | 385 | 432 | |
| 120" | 118 | 139 | 159 | 176 | 241 | 304 | 351 | 401 | 449 | |

Longer sizes are available with some limitations, contact customer service for pricing and information

ROOM DARKENING

| | | <— Width —> | | | | | | | | |
|------------------|------|-------------|-----|-----|-----|-----|-----|-----|-----|-----|
| | | 24" | 30" | 36" | 42" | 48" | 60" | 72" | 84" | 96" |
| Height ↑ ↓ | 36" | 56 | 66 | 73 | 81 | 100 | 129 | 147 | 166 | 185 |
| | 42" | 61 | 72 | 80 | 89 | 109 | 142 | 163 | 184 | 205 |
| | 48" | 66 | 76 | 87 | 97 | 118 | 153 | 176 | 201 | 224 |
| | 54" | 71 | 82 | 93 | 104 | 129 | 165 | 192 | 218 | 243 |
| | 60" | 75 | 88 | 98 | 113 | 139 | 179 | 206 | 234 | 263 |
| | 66" | 80 | 94 | 105 | 120 | 147 | 189 | 220 | 251 | 282 |
| | 72" | 83 | 98 | 113 | 128 | 157 | 203 | 235 | 268 | 302 |
| | 78" | 107 | 125 | 143 | 162 | 215 | 272 | 317 | 359 | 402 |
| | 84" | 113 | 131 | 151 | 170 | 227 | 286 | 331 | 380 | 425 |
| | 90" | 117 | 137 | 159 | 179 | 239 | 302 | 349 | 399 | 448 |
| | 96" | 122 | 144 | 165 | 186 | 250 | 318 | 368 | 419 | 471 |
| | 102" | 126 | 149 | 172 | 195 | 262 | 330 | 386 | 439 | 494 |
| | 108" | 132 | 155 | 180 | 204 | 273 | 346 | 403 | 459 | 517 |
| 114" | 136 | 162 | 186 | 212 | 285 | 361 | 419 | 480 | 541 | |
| 120" | 142 | 167 | 194 | 220 | 298 | 374 | 437 | 501 | 563 | |

Longer sizes are available with some limitations, contact customer service for pricing and information

Prices subject to change without notice

DUAL SHADE PRICE CHARTS

(Add to Price of Shade) and
(Hobbled Option Not Available)

WITH LIGHT FILTERING

| | | ← Width → | | | | | | | | |
|----------|------|-----------|-----|-----|-----|-----|-----|-----|-----|-----|
| | | 24" | 30" | 36" | 42" | 48" | 60" | 72" | 84" | 96" |
| Height ↑ | 36" | 136 | 147 | 160 | 174 | 208 | 254 | 282 | 307 | 334 |
| | 42" | 140 | 151 | 164 | 180 | 214 | 262 | 291 | 319 | 346 |
| | 48" | 142 | 154 | 168 | 184 | 221 | 269 | 301 | 328 | 359 |
| | 54" | 145 | 160 | 172 | 189 | 227 | 278 | 309 | 341 | 370 |
| | 60" | 147 | 163 | 176 | 194 | 233 | 285 | 320 | 350 | 383 |
| | 66" | 151 | 165 | 182 | 199 | 239 | 292 | 328 | 362 | 396 |
| | 72" | 153 | 170 | 186 | 204 | 246 | 301 | 339 | 373 | 412 |
| | 78" | 203 | 221 | 241 | 263 | 350 | 426 | 475 | 521 | 567 |
| | 84" | 206 | 226 | 246 | 269 | 360 | 435 | 486 | 535 | 583 |
| | 90" | 209 | 229 | 250 | 276 | 367 | 446 | 498 | 549 | 600 |
| | 96" | 212 | 234 | 257 | 281 | 375 | 455 | 512 | 562 | 615 |
| | 102" | 215 | 239 | 261 | 286 | 384 | 466 | 522 | 578 | 632 |
| | 108" | 219 | 242 | 265 | 292 | 392 | 476 | 535 | 592 | 654 |
| 114" | 223 | 247 | 270 | 299 | 401 | 486 | 548 | 606 | 676 | |
| 120" | 226 | 250 | 277 | 304 | 408 | 496 | 559 | 624 | 697 | |

Longer sizes are available with some limitations, contact customer service for pricing and information

WITH ROOM DARKENING

| | | ← Width → | | | | | | | | |
|----------|------|-----------|-----|-----|-----|-----|-----|-----|-----|-----|
| | | 24" | 30" | 36" | 42" | 48" | 60" | 72" | 84" | 96" |
| Height ↑ | 36" | 151 | 166 | 182 | 201 | 234 | 286 | 321 | 353 | 386 |
| | 42" | 155 | 172 | 188 | 207 | 243 | 299 | 336 | 369 | 405 |
| | 48" | 161 | 176 | 194 | 215 | 252 | 311 | 349 | 387 | 424 |
| | 54" | 165 | 183 | 202 | 223 | 262 | 323 | 364 | 404 | 444 |
| | 60" | 168 | 188 | 209 | 230 | 272 | 335 | 378 | 419 | 461 |
| | 66" | 173 | 194 | 215 | 239 | 282 | 346 | 393 | 436 | 480 |
| | 72" | 179 | 201 | 221 | 246 | 291 | 359 | 407 | 454 | 499 |
| | 78" | 233 | 259 | 285 | 315 | 409 | 498 | 562 | 623 | 686 |
| | 84" | 238 | 264 | 292 | 323 | 422 | 514 | 580 | 644 | 709 |
| | 90" | 242 | 271 | 301 | 331 | 433 | 527 | 598 | 666 | 733 |
| | 96" | 248 | 279 | 308 | 342 | 446 | 542 | 616 | 687 | 756 |
| | 102" | 252 | 284 | 317 | 350 | 457 | 558 | 634 | 708 | 782 |
| | 108" | 259 | 291 | 323 | 360 | 469 | 573 | 653 | 730 | 806 |
| 114" | 263 | 298 | 330 | 368 | 480 | 588 | 671 | 749 | 829 | |
| 120" | 268 | 303 | 340 | 378 | 494 | 603 | 689 | 770 | 853 | |

Longer sizes are available with some limitations, contact customer service for pricing and information

Prices subject to change without notice

EDGE BANDING OPTIONS

(Add to Price of Shade)

AVAILABLE STYLES



WATERFALL SHADE

- Min Width 12" Min Height 24"
- Max Width 96" Max Height 120"
- No Front Valance, 4" Back Valance
- Not Available Top Down/ Bottom Up



FLAT FOLD SHADE

- Min Width 12" Min Height 24"
- Max Width 96" Max Height 120"
- 6" Front Valance



HOBBLED SHADE

- Min Width 12" Min Height 24"
- Max Width 96" Max Height 96"
- 6" Front Valance

1/2" TWILL EDGE BINDING - SEWN ON

| | | ← Width → | | | | | | | |
|------------|-----------|-----------|-----|-----|-----|-----|-----|------|------|
| | | 36" | 48" | 60" | 72" | 84" | 96" | 108" | 120" |
| ↑ Height ↓ | FLAT FOLD | 53 | 60 | 68 | 75 | 86 | 95 | 107 | 111 |
| | WATERFALL | 53 | 60 | 68 | 75 | 86 | 95 | 107 | 111 |
| | HOBBLED | 69 | 78 | 89 | 97 | 110 | 124 | 137 | 147 |

Note: Edge Binding not available across bottom of cordless shades. | Note: 1 1/2" Twill Binding will have mitered corners.

1 1/2" TWILL EDGE BINDING - SEWN ON

| | | ← Width → | | | | | | | |
|------------|-----------|-----------|-----|-----|-----|-----|-----|------|------|
| | | 36" | 48" | 60" | 72" | 84" | 96" | 108" | 120" |
| ↑ Height ↓ | FLAT FOLD | 107 | 122 | 139 | 154 | 176 | 201 | 226 | 248 |
| | WATERFALL | 107 | 122 | 139 | 154 | 176 | 201 | 226 | 248 |
| | HOBBLED | 139 | 159 | 180 | 201 | 228 | 261 | 293 | 322 |

Note: Edge Binding not available across bottom of cordless shades. | Note: 1 1/2" Twill Binding will have mitered corners.

Prices subject to change without notice

EDGE BANDING OPTIONS

ADDITIONAL INFORMATION AND SPECIFICATIONS

EDGE BRANDING

- Available in 1/2" and 1 1/2" Widths
- Mitered Corners for 1 1/2" Edge Banding
- Fabric Sewn on (No Fabric Sewn on Bottom of Cordless Shade)

PRIVACY OR BLACKOUT LINING

- Back Side Color is Off White
- 5 Colors of Blackout Lining Available
- 5 Colors of Privacy Liner Available

TOP DOWN/BOTTOM UP (TD/BU)

- Flat Fold Style Only
- Not Available with Loop Control, Cordless, or 2-on-1 Headrail
- Min Width 18" – Max Size is 72" x 72"

2 ON 1 (3 ON 1) HEADRAIL

- Flat Fold and Waterfall Style Only
- Not Available in TD/BU
- Multiple Shades with Loop Control Will Have Multiple Loops
- Min Width 24" – Max Size is 120"

UPENDED HEADRAIL

- Depth 3/4" Height 1 1/2"
- Not Available in Cordless or Dual Shades

LOOP CONTROL

- Metal Chain Only (Stainless Steel or Bronze Only)
- Wood Headrail is 2 1/2"
- Not Available in TD/BU
- Min Width 24" – Max Width 96" – Max Height 96"

CORDLESS SHADE

- Flat Fold and Waterfall Style Only
- Wood Headrail is 1 1/2"
- Not Available in TD/BU, Loop Control, or Hobbled Shades

DUAL SHADE

- Flat Fold and Waterfall Style Only
- Back Shade Length is 1/2" Shorter than the Front Shade
- Not Available in TD/BU, Loop Control, or Hobbled Shades
- Right Control Operates Shade/Left Control Operates Liner
- Wood Headrail is 2 1/2"

HOBBLLED VALANCE

- Available in 12" Double Hobble or 18" Triple Hobble
- 6" Folds
- Wood Headrail is 1 1/2"

MOTORIZATION OPTION

- Flat Fold and Waterfall Style
- Not Available in TD/BU Shades
- Call for Pricing and Options

STACKING CHART & MINIMUM DEPTH REQUIREMENTS

| | HEADRAIL DIMENSIONS | | INSIDE MOUNT | | |
|---|---------------------|--------|--------------|-------------|--------------------|
| | DEPTH | HEIGHT | MIN DEPTH | FLUSH MOUNT | OUTSIDE |
| STANDARD HEADRAIL (CORD-LOCK, TDBU, CORDLESS) | 1 1/2" | 3/4" | 1 1/2" | 3/4" | 2' OF FLAT SURFACE |
| LOOP CONTROL & DUAL SHADE | 2 1/2" | 3/4" | 2 1/2" | 3/4" | |

| STACKING CHART (BASED UPON SHADE LENGTH) | | | | | | |
|--|-----------------------|------|------|------|------|------|
| | | 24" | 48" | 72" | 96" | 120" |
| APPROX HEIGHT | FLAT FOLD & WATERFALL | 7.5" | 7.5" | 7.5" | 8" | 8.5" |
| | HOBBLLED | 8.5" | 8.5" | 8.5" | 9" | 9.5" |
| APPROX THICKNESS | FLAT FOLD & WATERFALL | 1.5" | 2.5" | 3.5" | 4.5" | 5.5" |
| | HOBBLLED | 2.5" | 3" | 3.5" | 4.5" | 5.5" |

CHILD SAFETY & WARRANTY

CHILD SAFETY

Every product we send out meets or exceeds the latest safety standards as set forth by the Consumer Product Safety Council and the Window Covering Manufacturers Association. For enhanced safety, Automated Motorized Shades offers cordless and motorized window treatments.

REMEMBER THESE SAFETY RULES...

- For children's bedrooms only install window coverings that are cordless.
- Any window coverings in your home that were made before 2001, should be replaced with today's newer, safer models.
- Do not place furniture near windows that have window coverings with cords.
- Keep all cords out of reach from small children. Do this by securing tasseled pull cords out of reach with a cord cleat, and anchoring continuous-loop cords to the wall with safety devices.
- Always be sure to lock and firmly secure cords in position.
- Products such as Roman or Woven Wood Shades that have accessible back cords, should not be installed within reach of children.

All products come with safety labels attached. This is to help raise awareness of the potential safety risks associated with the products you purchase. If you have any concerns, please do not hesitate to contact us directly. You may also directly contact any of the associations that create the safety standards with any questions or concerns. Child safety is our top priority!

WARRANTY

Automated Motorized Shades guarantees all products manufactured in our facility to be free from defects due to faulty workmanship and/or materials. We are so confident about our quality and dependability that we back our manual shades with a limited lifetime warranty, our motors with a 5 year limited warranty, and our custom printed shades with a 3 year warranty against fading. All warranties are effective from the original invoice date of the product.

This guarantee does not apply to damage to exterior shades caused by high winds and/or extreme weather conditions. Any roller shade or parts which fail due to abuse, accident, theft, alterations, improper use or

installation, or gradual color fading, are also excluded from this warranty.

Automated Motorized Shades reserves the right to inspect products and will replace or repair any product found to be defective as a result of faulty workmanship or materials.

Shipping charges, trip charges and labor costs for measuring and installation and/or removal of old or current products are excluded. This

warranty is available to the original owner/purchaser and is non-transferable. Automated Motorized

Shades' warranty is designed to ensure a thoroughly satisfying experience with your window treatment product. Certain restrictions may apply.

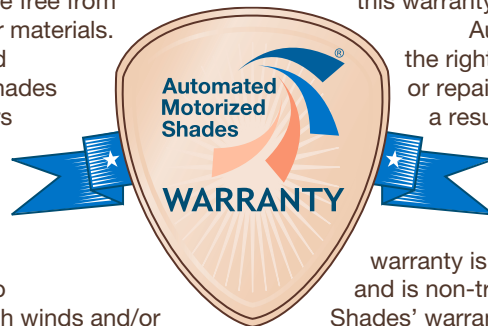



**MOTORIZED DRAPERY
TRACK COLLECTION**
PRICING GUIDE

TABLE OF CONTENTS

| | |
|---|---|
| Pricing | 1 |
| Remotes, Controls & Integration | 1 |
| Somfy Irismo™ 35 Mini 24V DC RTS Motorized Drapery Track | 2 |
| Somfy Irismo™ 45 Wirefree RTS Battery Motorized Drapery Track | 2 |
| 120v Somfy Glydea Motorized Drapery Track | 3 |
| 5060 Classic Motorized Drapery Track with RTS Receiver | 4 |
| 5060 Classic Motorized Drapery Track | 5 |
| Drapery Height Adjustments | 6 |
| Curves & Bends..... | 7 |
| Template Instructions..... | 8 |
| Child Safety & Warranty | 9 |

PRICING MOTORIZATION

This motorization price guide is designed to make pricing automated drapery tracks a simple and easy process. Just follow this step by step guide (as outlined below and on each of the drapery track system pricing pages) to calculate a fast, accurate price for all of your motorized drapery track needs.

STEPS FOR PRICING

1. Determine what type of motorization/power choice best suits your customer's needs
2. Find the price for your motorization following the easy steps outlined on the product pages
3. Add any surcharges at the bottom of the page and total all prices
4. Apply any discounts
5. Using our order form, Email your orders to orders@amsshades.com or fax 954.974.0529

REMOTES, CONTROLS AND INTEGRATION

Please refer to the Motorization Price Guide , pages 6-8 for remotes, controls and integration options. All of which are applicable with any Motorized Drapery Track option.

IRISMO

SOMFY IRISMO™ 35 MINI 24V DC RTS MOTORIZED DRAPERY TRACK SOMFY IRISMO™ 45 WIREFREE RTS BATTERY MOTORIZED DRAPERY TRACK



STEP 1: MOTOR SPECIFICATIONS, BRACKETS, & DRAPERY TRACK PRICING

MOTOR SPECIFICATIONS

| | | | |
|-------------------|--------------------------------------|------------------------------------|--------|
| Motor..... | Irismo 35 RTS or DCT & Irismo 45 RTS | Minimum Width | 24" |
| Power Source..... | 24 volt & Battery | Maximum Width (One Way Draw) | 288" |
| Control Type..... | RTS | Maximum Weight Irismo 35..... | 77 lbs |
| | | Maximum Weight Irismo 45..... | 99 lbs |

| Rod Size | 48" | 60" | 72" | 84" | 96" | 108" | 120" | 132" | 144" | 156" | 168" | 180" |
|-----------------------------|------|------|------|------|------|------|------|------|------|------|------|------|
| Irismo 35 Mini DC PP | 1860 | 1921 | 1981 | 2042 | 2100 | 2160 | 2221 | 2281 | 2341 | 2401 | 2461 | 2522 |
| Irismo 45 Battery PP | 1860 | 1921 | 1981 | 2042 | 2100 | 2160 | 2221 | 2281 | 2341 | 2401 | 2461 | 2522 |
| Irismo 35 Mini DC RF | 2131 | 2199 | 2270 | 2338 | 2406 | 2476 | 2545 | 2614 | 2683 | 2751 | 2821 | 2889 |
| Irismo 45 Battery RF | 2131 | 2199 | 2270 | 2338 | 2406 | 2476 | 2545 | 2614 | 2683 | 2751 | 2821 | 2889 |
| Rod Size | 192" | 204" | 216" | 228" | 240" | 252" | 264" | 276" | 288" | 300" | 312" | 324" |
| Irismo 35 Mini DC PP | 2580 | 2641 | 2701 | 2760 | 2821 | 2881 | 2942 | 3000 | 3060 | 3121 | 3181 | 3241 |
| Irismo 45 Battery PP | 2580 | 2641 | 2701 | 2760 | 2821 | 2881 | 2942 | 3000 | 3060 | 3121 | 3181 | 3241 |
| Irismo 35 Mini DC RF | 2851 | 2919 | 2989 | 3058 | 3126 | 3197 | 3265 | 3333 | 3402 | 3472 | 3541 | 3609 |
| Irismo 45 Battery RF | 2851 | 2919 | 2989 | 3058 | 3126 | 3197 | 3265 | 3333 | 3402 | 3472 | 3541 | 3609 |

Irismo 45 - Rechargeable LI-ION Battery included in Track Pricing | Irismo 35 - 24V DC Power Supply Included

STEP 2: SELECT YOUR POWER - POWER OPTIONS

| | | |
|---------------|---|---------------|
| OPTION | SOMFY GLYDEA® IRISMO 45 WIREFREE MOTOR OPTIONS (DC) | RETAIL |
| 1..... | Battery Charger for Irismo 45 Wirefree RTS Motor..... | \$210 |
| 2..... | Additional or Replacement 26.5V Rechargeable LI-Ion Battery | \$699 |
| OPTION | AC MOTOR OPTIONS | RETAIL |
| 1..... | 10' Power Cord with Grounded Plug | Included |
| | <i>Custom Cord Lengths Available Up to 24' Add \$66</i> | |

STEP 3: SELECT YOUR CONTROL - CONTROL OPTIONS

Information and additional control options page 6-8

| | | | |
|---|---|---------------------|-------|
| 1..... | Telis - 1 Channel RTS Remote (White)..... | \$134 | |
| 2..... | Telis - 4 Channel RTS Remote (White)..... | \$185 | |
| 3..... | Telis - 16 Channel RTS Remote (White)..... | \$561 | |
| 4..... | MyLink | \$475 | |
| 5..... | URTSI (Universal Radio Technology Somfy Interface)..... | \$1068 | |
| RS-485 Motor Setting & Address Reader Tool* | \$640 | SDN Extender..... | \$950 |
| DCT to RS 485 Module | \$235 | Data Hub | \$185 |
| DCT to Z-Wave® Module..... | \$345 | Data Hub Plus | \$600 |
| DCT to Zigbee Module | \$360 | | |

**Motor Setting & Address Reader Tool may be reused for any project using an RS485 Motor *Options not available for Irismo 45 Wirefree RTS Battery Motorized Drapery Track*

SURCHARGES

| | |
|------------------------------------|-------|
| Crate Charge (per crate)..... | \$268 |
| Continuous Curve (per track) | \$539 |
| 45/90 Radius (per bend)..... | \$269 |

Prices subject to change without notice

GLYDEA

120 VOLT SOMFY GLYDEA® MOTORIZED DRAPERY TRACK



STEP 1: MOTOR SPECIFICATIONS, BRACKETS, & DRAPERY TRACK PRICING

MOTOR SPECIFICATIONS

CHART

| | | | |
|-------------------|-------------------|------------------------------------|---------|
| Motor..... | DR 35 & DR 60-RTS | Minimum Width | 24" |
| Power Source..... | 120 volt | Maximum Width (One Way Draw) | 288" |
| Control Type..... | RTS | Maximum Weight | 240 lbs |

Additional controls and interfaces are also available.

Please contact customer service for RS-485 interface, ZigBee® module, and Z-Wave® module information. See pricing below.

| Rod Size | 48" | 60" | 72" | 84" | 96" | 108" | 120" | 132" | 144" | 156" | 168" | 180" |
|--------------------|------|------|------|------|------|------|------|------|------|------|------|------|
| 35-DCT Pinch Pleat | 1801 | 1860 | 1921 | 1981 | 2042 | 2100 | 2160 | 2221 | 2281 | 2341 | 2401 | 2461 |
| 35-DCT Ripplefold | 2070 | 2140 | 2209 | 2278 | 2347 | 2415 | 2485 | 2554 | 2623 | 2692 | 2760 | 2830 |
| 35-RTS Pinch Pleat | 1860 | 1921 | 1981 | 2042 | 2100 | 2160 | 2221 | 2281 | 2341 | 2401 | 2461 | 2522 |
| 35-RTS Ripplefold | 2131 | 2199 | 2270 | 2338 | 2406 | 2476 | 2545 | 2614 | 2683 | 2751 | 2821 | 2889 |
| 60-DCT Pinch Pleat | 2042 | 2100 | 2160 | 2221 | 2281 | 2341 | 2401 | 2461 | 2522 | 2580 | 2641 | 2701 |
| 60-DCT Ripplefold | 2310 | 2380 | 2449 | 2517 | 2588 | 2656 | 2724 | 2795 | 2863 | 2932 | 3000 | 3070 |
| 60-RTS Pinch Pleat | 2100 | 2160 | 2221 | 2281 | 2341 | 2401 | 2461 | 2522 | 2580 | 2641 | 2701 | 2760 |
| 60-RTS Ripplefold | 2370 | 2440 | 2509 | 2578 | 2646 | 2716 | 2785 | 2853 | 2924 | 2992 | 3060 | 3091 |
| Rod Size | 192" | 204" | 216" | 228" | 240" | 252" | 264" | 276" | 288" | 300" | 312" | 324" |
| 35-DCT Pinch Pleat | 2522 | 2580 | 2641 | 2701 | 2760 | 2821 | 2881 | 2942 | 3000 | 3060 | 3121 | 3181 |
| 35-DCT Ripplefold | 2790 | 2861 | 2929 | 2997 | 3068 | 3136 | 3205 | 3273 | 3343 | 3412 | 3480 | 3551 |
| 35-RTS Pinch Pleat | 2580 | 2641 | 2701 | 2760 | 2821 | 2881 | 2942 | 3000 | 3060 | 3121 | 3181 | 3241 |
| 35-RTS Ripplefold | 2851 | 2919 | 2989 | 3058 | 3126 | 3197 | 3265 | 3333 | 3402 | 3472 | 3541 | 3609 |
| 60-DCT Pinch Pleat | 2760 | 2821 | 2881 | 2942 | 3000 | 3060 | 3121 | 3181 | 3241 | 3301 | 3360 | 3421 |
| 60-DCT Ripplefold | 3031 | 3100 | 3169 | 3238 | 3306 | 3376 | 3444 | 3514 | 3583 | 3651 | 3721 | 3790 |
| 60-RTS Pinch Pleat | 2821 | 2881 | 2942 | 3000 | 3060 | 3121 | 3181 | 3241 | 3301 | 3360 | 3421 | 3480 |
| 60-RTS Ripplefold | 3129 | 3160 | 3229 | 3297 | 3367 | 3435 | 3505 | 3574 | 3642 | 3712 | 3780 | 3850 |

STEP 2: SELECT YOUR POWER - POWER OPTIONS (PLUG-IN OR HARD WIRED)

| | | |
|---|---|----------|
| OPTION | 120 VOLT POWER SOURCE | RETAIL |
| 1..... | 10' Power Cord with Grounded Plug | Included |
| <i>Custom Cord Lengths Available Up to 24' Add \$66</i> | | |

STEP 3: SELECT YOUR CONTROL - CONTROL OPTIONS

| | | |
|--------|--|-------|
| 1..... | Telis - 1 Channel RTS Remote (White)..... | \$134 |
| 2..... | Telis - 4 Channel RTS Remote (White)..... | \$185 |
| 3..... | Telis - 16 Channel RTS Remote (White)..... | \$561 |

SURCHARGES

| | | | |
|-------------------------------------|-------|------------------------------------|-------|
| RS-485 (Call for Information)..... | \$70 | Crate Charge (per crate)..... | \$268 |
| Zigbee® (Call for Information)..... | \$470 | Continuous Curve (per track) | \$539 |
| Z-Wave® (Call for information)..... | \$470 | 45/90 Radius (per bend)..... | \$269 |

Prices subject to change without notice

5060 CLASSIC - RTS

5060 CLASSIC MOTORIZED DRAPERY TRACK WITH RTS RECEIVER



STEP 1: MOTOR SPECIFICATIONS, BRACKETS, & DRAPERY TRACK PRICING

MOTOR SPECIFICATIONS

CHART

| | | | |
|-------------------|-------------------------------|------------------------------------|---------|
| Motor..... | 5060-30W & 5060-45W | Minimum Width | 24" |
| Power Source..... | 120 volt | Maximum Width (One Way Draw) | 576" |
| Control Type..... | Wall Switch or Control System | Maximum Weight | 240 lbs |

| Rod Size | 48" | 72" | 96" | 120" | 144" | 168" | 192" | 216" | 240" | 264" | 288" | 324" |
|---------------------------|------|------|------|------|------|------|------|------|------|------|------|------|
| 30W RTS | 2149 | 2310 | 2472 | 2661 | 2823 | 2979 | 3136 | 3292 | 3448 | 3604 | 3761 | N/A |
| 45W RTS | 2373 | 2532 | 2691 | 2845 | 3000 | 3157 | 3313 | 3470 | 3624 | 3780 | 3937 | 4170 |
| 35W RTS Ripplefold | 2382 | 2567 | 2754 | 2971 | 3157 | 3336 | 3515 | 3695 | 3875 | 4055 | 4234 | N/A |
| 45W RTS Ripplefold | 2640 | 2822 | 3005 | 3182 | 3360 | 3540 | 3720 | 3899 | 4079 | 4258 | 4437 | 4707 |

STEP 2: SELECT YOUR POWER - POWER OPTIONS (PLUG-IN OR HARD WIRED)

OPTION

120 VOLT POWER SOURCE

RETAIL

| | | |
|--------|---|----------|
| 1..... | RTS Receiver with 10' Power Cord and 6' Power Cord..... | Included |
|--------|---|----------|

Custom Cord Lengths Available Up to 24' Add \$66

STEP 3: SELECT YOUR CONTROL - CONTROL OPTIONS

Please refer to RTS Remote controls in Motorization Price Book from pricing and options

SURCHARGES

| | |
|------------------------------------|-------|
| Crate Charge (per crate)..... | \$268 |
| Continuous Curve (per track) | \$539 |
| 45/90 Radius (per bend)..... | \$269 |

Prices subject to change without notice

5060 CLASSIC

5060 CLASSIC MOTORIZED DRAPERY TRACK



STEP 1: MOTOR SPECIFICATIONS, BRACKETS, & DRAPERY TRACK PRICING

MOTOR SPECIFICATIONS

CHART

| | | | |
|-------------------|-------------------------------|------------------------------------|---------|
| Motor..... | 5060-30W & 5060-45W | Minimum Width | 24" |
| Power Source..... | 120 volt | Maximum Width (One Way Draw) | 576" |
| Control Type..... | Wall Switch or Control System | Maximum Weight | 240 lbs |

| Rod Size | 48" | 72" | 96" | 120" | 144" | 168" | 192" | 216" | 240" | 264" | 288" | 324" |
|-----------------------|------|------|------|------|------|------|------|------|------|------|------|------|
| 30W | 1549 | 1711 | 1873 | 2062 | 2223 | 2380 | 2535 | 2692 | 2848 | 3005 | 3160 | N/A |
| 45W | 1774 | 1932 | 2091 | 2244 | 2401 | 2557 | 2713 | 2869 | 3024 | 3181 | 3336 | 3570 |
| 35W Ripplefold | 1781 | 1967 | 2154 | 2370 | 2557 | 2737 | 2915 | 3095 | 3274 | 3455 | 3635 | N/A |
| 45W Ripplefold | 2041 | 2222 | 2404 | 2581 | 2760 | 2940 | 3120 | 3300 | 3478 | 3658 | 3836 | 4106 |

STEP 2: SELECT YOUR POWER - POWER OPTIONS (PLUG-IN OR HARD WIRED)

OPTION

120 VOLT POWER SOURCE

RETAIL

| | | |
|--------|--|----------|
| 1..... | Up to 6' Power Cord with or without Grounded Plug..... | Included |
| 2..... | Wall Entry Plate with 6' Motor Cord, includes Motor Disconnect | \$119 |

Custom Cord Lengths Available Up to 24' Add \$66

STEP 3: SELECT YOUR WALL SWITCHES

Please refer to 120 Wall Switches in Motorization Price Book from pricing and options

SURCHARGES

| | | | |
|-------------------------------------|-------|------------------------------------|-------|
| RS-485 (Call for Information)..... | \$70 | Crate Charge (per crate)..... | \$268 |
| Zigbee® (Call for Information)..... | \$470 | Continuous Curve (per track) | \$539 |
| Z-Wave® (Call for information)..... | \$470 | 45/90 Radius (per bend)..... | \$269 |

Prices subject to change without notice

DRAPERY HEIGHT ADJUSTMENTS

GLYDEA

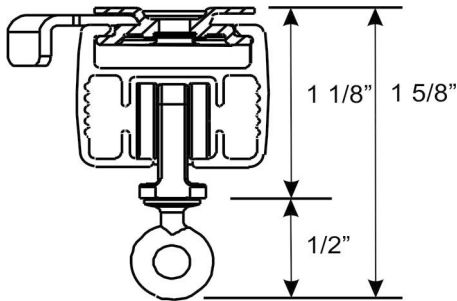

PINCH PLEAT

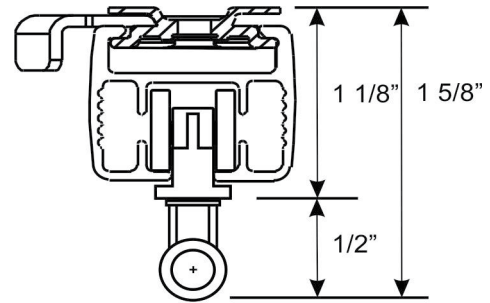

RIPPLEFOLD

5060 CLASSIC DRAPERY TRACK

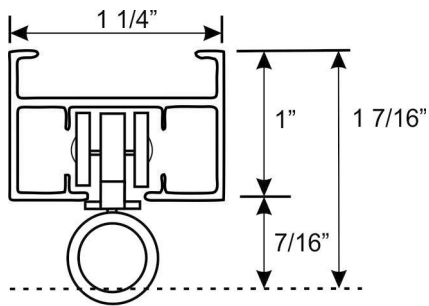

PINCH PLEAT

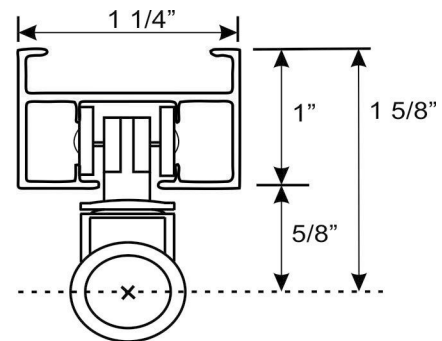

RIPPLEFOLD

CURVES & BENDS

AUTOMATED CONTROLS

BENDS

Tracks with bends are ideal for bay and corner windows. Track bends are available at a fixed radius of 13". For more information on how to measure for a bend, please see bottom of page and next.

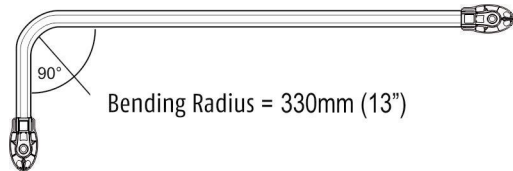

CURVES

Custom curves are ideal for bow windows and other special applications. For additional information on how to measure for a curve, and how to make a template, please see bottom of page and next.

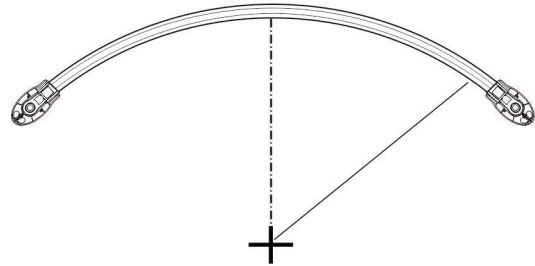

BRACKET MOUNTING RECOMMENDATIONS (TOP VIEW OF TRACK)

Automated Motorized Shades recommends 1 bracket by each pulley and 1 bracket every 24". Additionally, 1 bracket should be placed on each side of a splice if used.

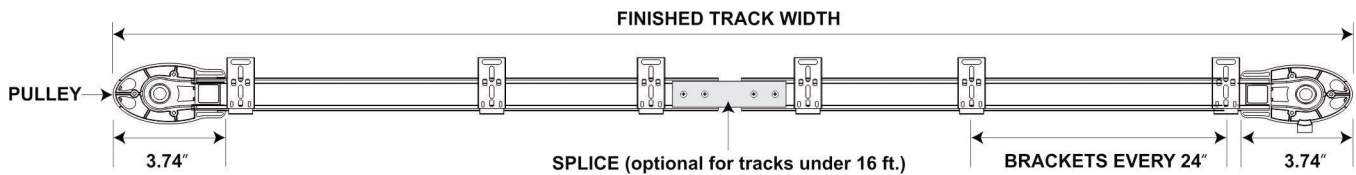

Note: Splices are not available on One Way Draw Rods

BENT DRAPERY TRACK MEASUREMENT FORM

The following dimensions are shown from the top view of the track and show various wall designs.

1. Choose the design that best fits your room setup.
2. Provide all of the proper wall measurements and degrees of all angles.
3. Provide the Return measurement "R" (distance from wall to front of drapery track as shown) and submit to Automated Motorized Shades.

NOTE: When fabricating your drapery, please add 1 1/2" to your return

STYLE 1 MEASUREMENT

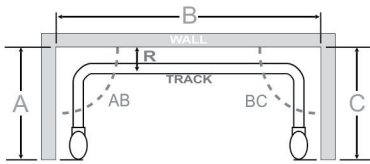

STYLE 2 MEASUREMENT

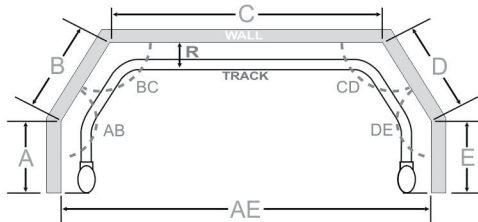

STYLE 3 MEASUREMENT

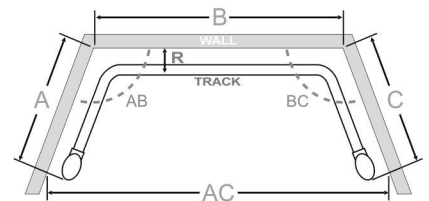

STYLE 4 MEASUREMENT

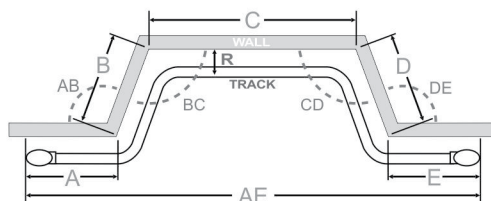

STYLE 5 MEASUREMENT

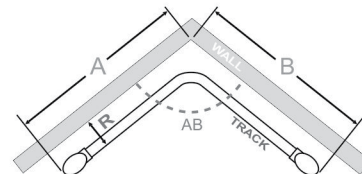

CREATING A TEMPLATE

DIRECTIONS FOR CREATING A TEMPLATE FOR DRAPERY CURVES AND BENDS

WHAT YOU NEED: • LARGE PIECE OF CONSTRUCTION PAPER • TAPE MEASURE • MARKER • TAPE

1. Start with a large piece of construction paper that exceeds the depth and length of the curve.
2. Place the paper on the floor or ceiling depending on the orientation of the curve.
3. Secure the paper with the tape.
4. Clearly define the stacking side, motor placement, pocket depth and center line of track with the marker.
5. Mark the radius of the curve
6. Please provide as much detail as possible and all templates must include the following:
 - Indicate “room side”
 - Note how the template was created
 - Template created on the floor facing up (See Figure 1)
 - Template created on the ceiling facing down (See Figure 2) (Preferred method)
 - Purchase order number
 - Customer name
 - Company name and account number
7. Note the distance from the wall or the window to the center of the track.

Note: Be sure to clear all possible obstructions such as handles, sills etc.
8. Identify the following measurement points:
 - Placement of motor
 - Exact stopping point of track on template
 - Total measurement of curve (See Figure 4-“C”)

*Please call Automated Motorized Shades for specialty curving applications.
Depending on your particular application, your project may require special attention.*

FIGURE 1: TEMPLATE ON THE FLOOR FACING UP

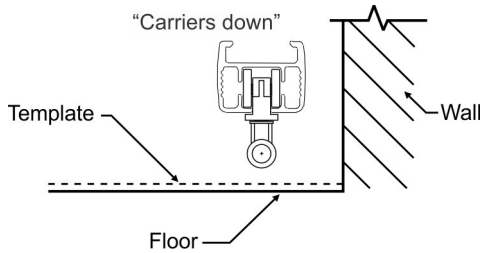

FIGURE 2: TEMPLATE ON THE CEILING FACING DOWN

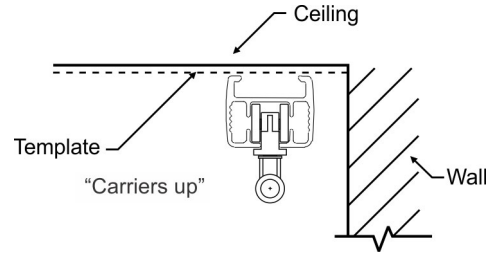

FIGURE 3: CRITICAL DIMENSIONS OF A CURVED TRACK

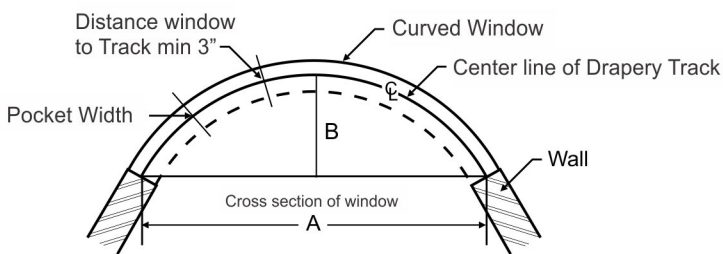
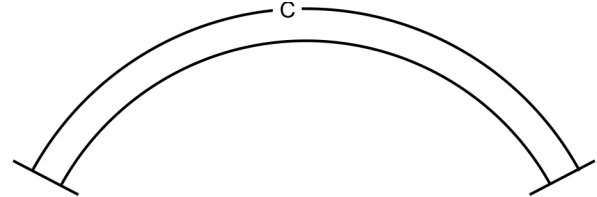

FIGURE 4: TOTAL MEASUREMENT OF CURVE



TEMPLATE SUBMISSION INSTRUCTIONS

Attach a copy of the purchase order to the template. Roll up template and place in a mailing tube. **DO NOT FOLD TEMPLATE**

Mail to:
Automated Motorized Shades
3117 NW 25th Avenue
Pompano Beach, FL 33069
Attn: Drapery Department

Note: When mailing, be sure to:

- Get a tracking number
- Include your return address
- Include your purchase order number on the label

ACCEPTABLE MATERIALS FOR MAKING TEMPLATES:

- Kraft Paper • Butcher Paper • Construction Paper
- Automated Motorized Shades will not accept templates made from the following materials:
- Newspaper • Plastic • Wax Paper • Fabric • Tissue Paper
 - Roofing Paper • Existing Arch Shades • Wrapping Paper or any templates that require assembly of any kind

Note: If the material used to make a template stretches, tears easily or will not lay flat it WILL NOT be used.

CHILD SAFETY & WARRANTY

CHILD SAFETY

Every product we send out meets or exceeds the latest safety standards as set forth by the Consumer Product Safety Council and the Window Covering Manufacturers Association. For enhanced safety, Automated Motorized Shades offers cordless and motorized window treatments.

REMEMBER THESE SAFETY RULES...

- For children's bedrooms only install window coverings that are cordless.
- Any window coverings in your home that were made before 2001, should be replaced with today's newer, safer models.
- Do not place furniture near windows that have window coverings with cords.
- Keep all cords out of reach from small children. Do this by securing tasseled pull cords out of reach with a cord cleat, and anchoring continuous-loop cords to the wall with safety devices.
- Always be sure to lock and firmly secure cords in position.
- Products such as Roman or Woven Wood Shades that have accessible back cords, should not be installed within reach of children.

All products come with safety labels attached. This is to help raise awareness of the potential safety risks associated with the products you purchase. If you have any concerns, please do not hesitate to contact us directly. You may also directly contact any of the associations that create the safety standards with any questions or concerns. Child safety is our top priority!

WARRANTY

Automated Motorized Shades guarantees all products manufactured in our facility to be free from defects due to faulty workmanship and/or materials. We are so confident about our quality and dependability that we back our manual shades with a limited lifetime warranty, our motors with a 5 year limited warranty, and our custom printed shades with a 3 year warranty against fading. All warranties are effective from the original invoice date of the product.

This guarantee does not apply to damage to exterior shades caused by high winds and/or extreme weather conditions. Any roller shade or parts which fail due to abuse, accident, theft, alterations, improper use or

installation, or gradual color fading, are also excluded from this warranty.

Automated Motorized Shades reserves the right to inspect products and will replace or repair any product found to be defective as a result of faulty workmanship or materials.

Shipping charges, trip charges and labor costs for measuring and installation and/or removal of old or current products are excluded. This

warranty is available to the original owner/purchaser and is non-transferable. Automated Motorized Shades' warranty is designed to ensure a thoroughly satisfying experience with your window treatment product. Certain restrictions may apply.

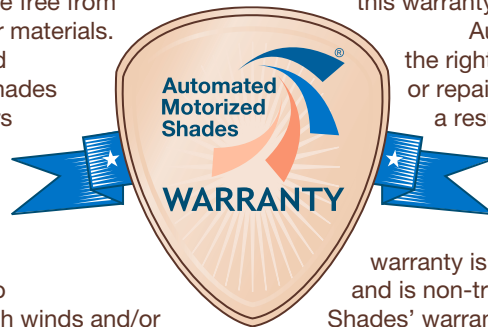

A modern exterior window and door system with a dark grey frame and a large glass pane. The window is partially open, revealing a wooden deck with outdoor furniture, including a table with a floral tablecloth and a wicker hot tub. The scene is brightly lit, suggesting a sunny day. The text "EXTERIOR SYSTEM COLLECTION" is overlaid in white at the bottom of the image.

EXTERIOR SYSTEM COLLECTION

TABLE OF CONTENTS

| | |
|-------------------------------|---|
| ZipShade® | 2 |
| Introduction..... | 2 |
| Maximum Sun Protection | 3 |
| Crystal View | 3 |
| Patented Zip System | 3 |
| Simplified Automation..... | 3 |
| Patented Zip System | 3 |
| Product Specifications..... | 4 |
| Recessed Installation..... | 4 |
| Operational Wind Speed..... | 5 |
| Cable Guide System | 6 |
| Introduction..... | 6 |
| Child Safety & Warranty | 7 |

ZIPSHADE®

INTRODUCTION

The Automated Motorized Shades® ZipShade® offers proven performance, high quality, superior design and easy installation. Wind tight in every position, thanks to the patented ZipShade® technology, flapping or tearing of screen fabrics is a thing of the past. The ZipShade® makes outdoor eating spaces more comfortable for occupants in any season.



IMPROVED COMFORT

The ZipShade® offers maximum sun protection and glare control for occupants.



EASY TO OPERATE

Offered exclusively with motorization, ZipShade® can be controlled with a hand-held remote or wall switch.



DURABILITY

Patented ZipShade® technology guarantees a fixed fabric with no wrinkles.



INSECT-PROOF

In the closed position, the ZipShade® is insect-proof, making outdoor conditions more comfortable.



WIND RESISTENT

The ZipShade® is operational in winds up to 80 mph*
* Wind rating subject to change based on shade size.



AUTOMATION

For full automation, ZipShade® can be controlled with a wind or sun sensor.



ZIPSHADE®

MAXIMUM SUN PROTECTION

When placed on the exterior facade, the Automated Motorized Shades® ZipShade® helps avoid overheating by filtering the direct sunlight that enters an interior space. This can result in decreased cooling and air conditioning costs and can reduce overall energy consumption by utilizing natural daylight. Depending on the type of fabric selected, different degrees of heat-resistance are possible. The ZipShade® can greatly reduce the use of artificial lighting while also reducing heat gain by not allowing sun rays to penetrate the glass exterior of the building.

The extensive range of fabric colors and profiles ensures that the ZipShade® is in perfect harmony with the architecture of your building, thus creating a pleasant environment.

CRYSTAL VIEW

In order to have optimal contact with the exterior, transparent Crystal view can be fitted in the ZipShade®.

PATENTED ZIP SYSTEM

The superior ZipShade® utilizes a patented zip system called Smooth Technology. The custom zipper is welded onto the edges of the shade fabric and inserted into the custom, 2-part side channel. This locking zipper guarantees a fixed fabric with no wrinkles. The interior of the channel contains a co-extruded self-lubricating PVC top coating which results in smooth, quiet operation.

SIMPLIFIED AUTOMATION

The ZipShade® can be paired with a sun sensor to provide maximum sun protection, even when the space is unoccupied. As the sun moved across the sky, the shades will automatically adjust according to the sun's position, optimizing energy efficiency.

PATENTED ZIP SYSTEM

The superior ZipShade® utilizes a patented zip system called Smooth Technology. The custom zipper is welded onto the edges of the shade fabric and inserted into the custom, 2-part side channel. This locking zipper guarantees a fixed fabric with no wrinkles. The interior of the channel contains a co-extruded self-lubricating PVC top coating which results in smooth, quiet operation.

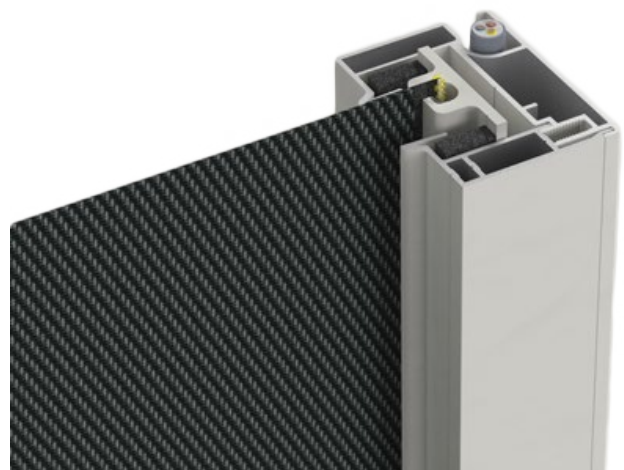

ZIPSHADE®

PRODUCT SPECIFICATIONS

There are three different ZipShade® sizes: ZipShade® 100, ZipShade® 100 Slim and ZipShade® 150. Each system has unique characteristics and can be installed in a variety of applications.

SHADE HEADBOX

The ZipShade® headbox is constructed of two aluminum profiles. The headbox is closed by means of a square front profile that hinges into the box. This construction of the headbox results in easy assembly and installation. Each end has a side console that supports the roller tube and is equipped with heavy duty pins that lock the headbox into the side channels.

FABRIC ROLL

The ZipShade® fabric roller is composed of steel and has a unique sunken groove to limit the impression of the fabric loop. This groove strongly reduces the horizontal line formation in the fabric.

BOTTOM BAR

The ZipShade® bottom bar is composed of extruded aluminum and is made heavier with a round bar of galvanized steel. For perfect connection with the sill, the bottom bar has a plastic darkening strip.

SIDE CHANNEL

The ZipShade® side channels are made of extruded aluminum. The external side channel consists of 2 parts. The internal channel is made of HPVC and is fitted with neoprene buffer zones to compensate for wind gusts. The zip, which is welded to the fabric, slides into the HPVC side channels and the fabric is 'held fast'.

RECESSED INSTALLATION

When specified in architectural plans, the ZipShade® 100 Slim can be recessed into the building. The ZipShade® 100 Slim headbox is specially constructed to ease installation by allowing the roller tube to be installed via the underside of the headbox. The Zipshade® 100 Slim is designed to completely conceal the headbox, side channels and bottom bar, when rolled up, so that the system seamlessly integrates into the structure.



ZIPSHADE® 100

Ideal for smaller openings.



ZIPSHADE® 150

Designed for larger applications up to 20' wide with a bottom bar that conceals in the head box for a practical, but sleek



ZIPSHADE® 100 SLIM

Side channels and headbox can be recessed into walls to provide a seamless appearance.

OPERATION WIND SPEED

OPERATIONAL WIND SPEED

The superior ZipShade® side channel technology results in extreme wind resistance. Thanks to the ingenious zip system, the shade fabric is windproof in any position. Due to the edging, the symmetrical zipper is positioned on both sides of the fabric and is firmly embedded in the zip guides. Testing has shown that the ZipShade® is resistant against a wind speed of up to 80mph* in a closed position which makes the ZipShade® one of the most weather resistant, sun protection screens on the market.

* Wind rating subject to change based on shade size.

ZIPSHADE® WIND RATING

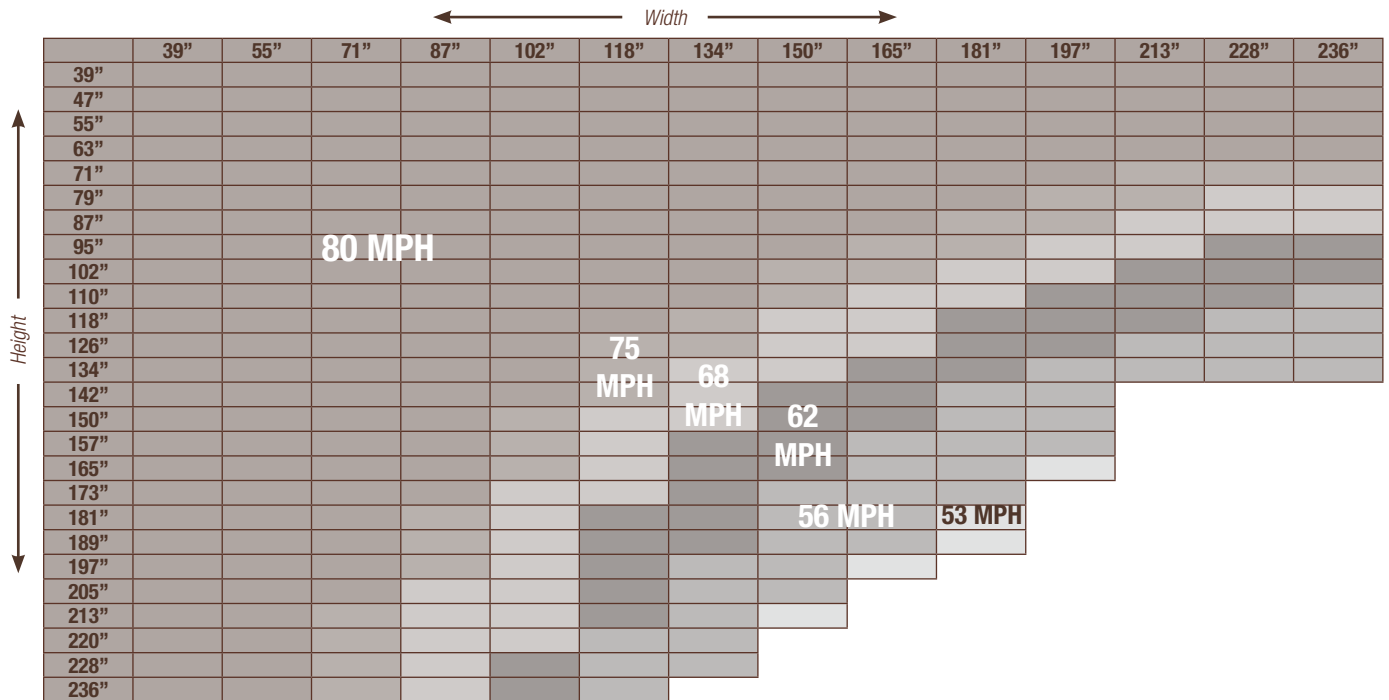

Wind tests performed on the ZipShade® installed in front of a window and manufactured using fiberglass shade fabric.

CABLE GUIDE SYSTEM

INTRODUCTION

The durable exterior Cable Guided System is a cost-effective shading solution for exterior applications. This heavy-duty system is made to withstand moisture and temperature fluctuation while keeping your customers comfortable. Made of stainless steel, guide wires are connected to the upper bracket and ground to stabilize the shade and prevent damage from outdoor weather conditions. This system preserves your outdoor view while allowing you to maximize heat gain reduction and control sunlight. Outdoor roller shades are a stylish addition to any patio, veranda, sun-room or courtyard, and can be rolled up when not in use.



CHILD SAFETY & WARRANTY

CHILD SAFETY

Every product we send out meets or exceeds the latest safety standards as set forth by the Consumer Product Safety Council and the Window Covering Manufacturers Association. For enhanced safety, Automated Motorized Shades offers cordless and motorized window treatments.

REMEMBER THESE SAFETY RULES...

- For children's bedrooms only install window coverings that are cordless.
- Any window coverings in your home that were made before 2001, should be replaced with today's newer, safer models.
- Do not place furniture near windows that have window coverings with cords.
- Keep all cords out of reach from small children. Do this by securing tasseled pull cords out of reach with a cord cleat, and anchoring continuous-loop cords to the wall with safety devices.
- Always be sure to lock and firmly secure cords in position.
- Products such as Roman or Woven Wood Shades that have accessible back cords, should not be installed within reach of children.

All products come with safety labels attached. This is to help raise awareness of the potential safety risks associated with the products you purchase. If you have any concerns, please do not hesitate to contact us directly. You may also directly contact any of the associations that create the safety standards with any questions or concerns. Child safety is our top priority!

WARRANTY

Automated Motorized Shades guarantees all products manufactured in our facility to be free from defects due to faulty workmanship and/or materials. We are so confident about our quality and dependability that we back our manual shades with a limited lifetime warranty, our motors with a 5 year limited warranty, and our custom printed shades with a 3 year warranty against fading. All warranties are effective from the original invoice date of the product.

This guarantee does not apply to damage to exterior shades caused by high winds and/or extreme weather conditions. Any roller shade or parts which fail due to abuse, accident, theft, alterations, improper use or

installation, or gradual color fading, are also excluded from this warranty.

Automated Motorized Shades reserves the right to inspect products and will replace or repair any product found to be defective as a result of faulty workmanship or materials.

Shipping charges, trip charges and labor costs for measuring and installation and/or removal of old or current products are excluded. This

warranty is available to the original owner/purchaser and is non-transferable. Automated Motorized Shades' warranty is designed to ensure a thoroughly satisfying experience with your window treatment product. Certain restrictions may apply.

